

Engineered
Made
In Germany



Harmonic Design

...simply harmonic sound

Catalog
2025



...simply harmonic sound

Harmonic Design

The Harmonic Design® Philosophy

The holistic system consisting of loudspeaker box, digital system controller and amplifier represents our understanding of a future-oriented system. The individual components are individually optimized and unfold their full potential in combination as a system: The sound pattern is faithful, the power is exceptional and the handling is simple.

Our cooperate goals

As a long-standing and reliable partner of many distributors, rental companies, system integrators, planners, musicians and producers, we want to continue to work alongside you and offer practical top-of-the-range products. The development of new, innovative technologies for the improvement of products plays a key role.

The promise

We are constantly face new, demand challenges, go on unprecedented paths and thus shift the boundaries of the possible. Our passion comes from our love for art and music. In search of uncompromising sound accuracy, minimal dimensions, superior quality and smart accessories, our goal is a harmonious design. All Harmonic Design® products are made by hand exclusively in Germany. Our top modern facilities ensure the best quality of every product.

What we provide

Harmonic Design® (hd) offers innovative products with practical orientation that operate due to their specifications, sound quality and diversity in the highest level available in the audio industry. Our products serve professional sound engineers, musicians, DJs, rental companies and system integrators as perfectly matched tools. We want to support you in all your applications and to offer you not only sophisticated products, but also a personal point of contact for questions, advice and support.

The handling and appearance are extremely minimal and unobtrusive, making the sound system almost invisible. This connects the audience with the performance of the artist to focus on the performance itself.

Yours faithfully,

Robin Maier
- Owner -



About us

...simply harmonic sound

Engineered
And Made
In Germany

„Made in Germany“ is more than just a label with global significance. We value local craftsmanship, which is why we obtain all processed materials and assemblies from specialist partners in Germany whenever possible. From the first design sketch and prototype to the end product: every component that bears the brand name Harmonic Design® is completely developed in-house and assembled by hand by our highly qualified technicians. Without exception, we create valuable and long-lasting quality products.

Perfect system concept.

Harmonic Design® systems consist of loudspeaker boxes, digital system controllers and amplifiers. The individual components are networked with one another and ensure ease of use, the highest sound quality and enormous reliability. The individual loudspeaker types are interchangeable in order to achieve the best possible results, depending on the application and requirement.

Audiophile top performance.

Harmonic Design® loudspeaker systems are well known for their neutral and linear sound. Using state-of-the-art methods and measuring techniques, the loudspeaker components are examined and improved down to the smallest detail. The linearity is characterized not only by the flat frequency response, but also by the impulse response accuracy, precisely graduated tonal depth and minimal distortions.



Harmonic Design® SmartFactory.

For the 40th company anniversary in June 2020, we moved into our new company headquarters in Neckarwestheim. For improved efficiency, we now combine all departments with over 3000m² under one roof. We combine the most modern high-tech production with traditional craft in the final assembly.

Our contribution to environmental protection.

Sustainability plays a major role for us, which is why we build our products to last. Product life cycles of well over 15 years belong to us contrary to the mainstream a matter of course. Short transport routes through regional suppliers avoid high emissions in transit. The resulting packaging material is largely reused. The entire company technology is energy-saving and our entire energy requirement is covered by the in-house photovoltaic system on the roof.

Owner-run family business.

As a Swabian family company, we are not subject to corporate cost pressure, but when selecting materials and components, we focus on quality that inspires.





Table of content

Index

Philosophy	02-03	hd C-Series Commercial Stick	24-25	hd 12CXN Stage Monitor	40-41	Systemproposals Choose Your Sound!	62-69
About us	04-05	hd M-Series PointSource Stick	26-27	hd MP-Series Multi Purpose Loudspeaker	42-43	hd AudioBar & VideoBar Collaboration	70-73
History	08-09	hd ML-Series LineArray Stick	28-29	hd HLS-Series HybridLineSource	44-51	hd AudioScreenSys Collaboration	74-75
hd Sub-Series Subwoofer	12-15	hd PL-Series PowerLine Stick	30-31	hd LSA-Series LineSourceArray	52-53	hd IC-Series Ceiling Speakers	76-76
hd P-Series Active System Subwoofer	16-17	Beamforming Technology Overview	32-33	hd SpaceAMP-Series DSP System Amplifier	54-55	hd PC-Series Pendant Speakers	77-77
hd Columns Overview	18-21	hd Beam-Series Beamforming Stick	35-37	hd Qi-Series DSP Installation Amplifier	56-57	Accessories Well thought out & useful	78-79
hd PLB Subwoofer Stick	22-23	hd CXN-Series Coaxial Loudspeaker	38-39	hd QT-Series DSP Touring Amplifier	58-59	References Fascinatingly versatile	80-83

Harmonic Design®

Over 40 years of experience

Harmonic Design® has stood for research, development and production of innovative loudspeaker systems and acoustic services since it was founded in 1980. We thought of systems early on and established the use of system controllers as early as 1988. In the early 1990s, the MLSSA measurement system took computer-aided loudspeaker development to a new level. The first digital signal processor with future-oriented filter options followed in 1994. In recent years we have been pioneering with technologies such as the revolutionary HybridLineSource, hd Beamforming and Collaboration Solutions.

- 1980 Foundation of **Harmonic Design GmbH** based in Rutesheim, Germany
Invention of "Hardy Amps", professional Bass and Guitar cabinets
- 1986 Unveiling PA speaker systems with specially developed glass fiber reinforced plastic horns to improve coverage and sensitivity
- 1988 Introduction of the **hd MPP3 and 903 System**: The first loudspeaker system with integrated speaker control processor and analogue system amplifier
- 1989 Extension of the manufacturing capacity and in-house production of wooden cabinets
- 1990 Harmonic Design GmbH named exclusive distributor of the world wide leading **MLSSA** measurement system in Europe
Calibration and acceptance of renewed sound system at Gottlieb-Daimler-Stadion in Stuttgart, Germany
- 1991 Invention of the **hd "CX"Pro-Series** consisting of "CX"Pro Top 12CX2, "CX"Pro Bass SW115 with HFC-technology, "CX"Pro ISP-AMP, first loudspeakers using coaxial loudspeaker designs
- 1994 Acoustic expert assessment for German Bundestag in Bonn, Germany
Introduction of the first digital room-speaker-processor **hd DSC1** with seamless control over every loudspeaker component
- 1995 Introduction of the **hd SYSTEM2000** loudspeakers and electronic devices with ground breaking new technology for loudspeaker system control and optimization, invention of GroupDelayCorrection algorithm, 2-stage limiters and import MLSSA measurement files to directly optimize the system in an all-in-one system
- 1996 **hd CS-Series** large scale touring sound system consisting of **hd FR-2122** top and **hd SW-218** subwoofer
- 1998 Unveiling **hd 8CX** and **hd 12CX** coaxials, active subwoofers **hd 18N** and **hd SW12-15P**, **hd Studio1** reference studio monitor



- 2000 Development of the PowerSound algorithm for improved sound reproduction
Release of the next generation Digital System Controller **hd DSC2** using FIR/IIR technology **hd SPA** modular horn loaded speaker system, **hd Sub15**
- 2006 Unveiling multichannel digital amplifier and integrated digital signal controller with 4x In / 6x 200 W Out and 4x In / 4x 400 W Out
Compact LineArray series **hd No3** and **hd No5** as well as stackable Coaxial LineArray **hd No7**
- 2008 Invention of PointSource Stick **hd M-Series** and LineArray Stick **hd ML-Series**
- 2012 Introduction of **hd P-Series** with High-End DSPs (FIR/IIR) and 4000W class-D amplifiers
- 2015 Expansion of the LineArray Stick portfolio by a high-performance loudspeaker with the **hd PL16**
hd Beamforming Technology with application in **hd ML-Series** and **hd PL-Series**
- 2016 Presentation of the revolutionary large PA system **hd HLS24** HybridLineSource
- 2020 Move into the new **SmartFactory** in Neckarwestheim with over 3,000 m² and in-house acoustic measuring room of the reference class
Introduction of the **hd AudioBar** and **hd VideoBar** as a plug & play collaboration system with integrated digital mixer and presenter functions
Expansion of the product portfolio with a columnar subwoofer **hd PLB**
- 2022 Introducing the new **hd QT** Series High Power Amplifiers
- 2024 Product portfolio expanded to include the **hd 10CXN**, **hd HLS16**, **hd HLS24-LT** and the **hd Sub21** and **hd Infra221** subwoofers
- 2025: World premiere of the SPACE system concept based on the new half 19" DSP amplifier **SpaceAMP1000**

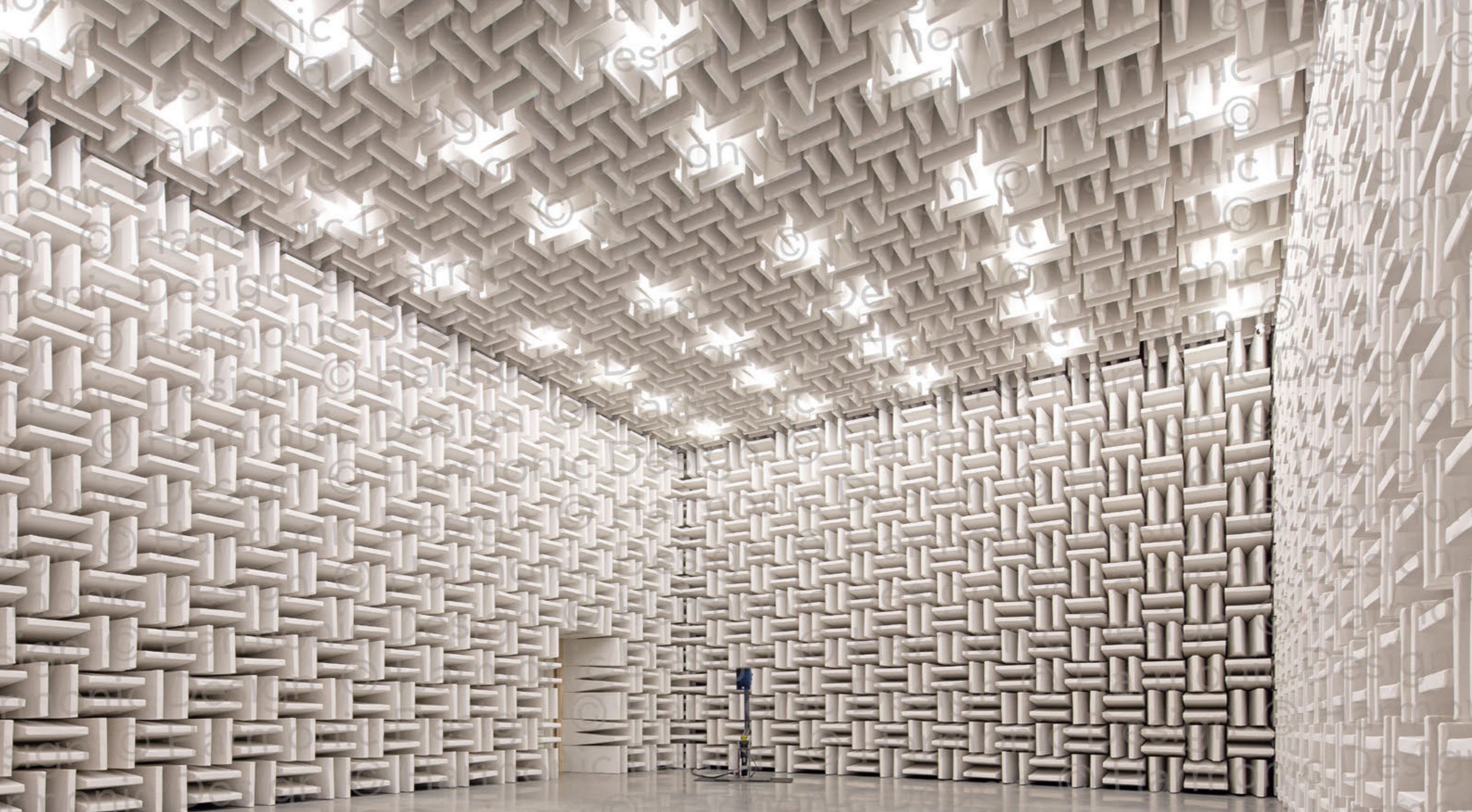

Sound is science
verifiable, quantifiable, objective

Harmonic Design EAR (ElectroAcousticResearch)
in-house half-space anechoic chamber according
to class 1 with 1,000 m³ room volume



hd Sub-Series

Subwoofer

The **hd Sub Series** consists of the passive, compact and powerful vented subwoofers **hd Slim265**, **hd Sub12**, **hd Sub15**, **hd Sub18** and **Sub21**. Our extensive experience in over 40 years of chassis development has led to the development of special chassis with large linear excursion, 3", 4" and 5" voice coils, fiberglass coil carrier and double spider. The generously dimensioned ventilation of the voice coil on the pole piece and spider ensures a high and continuous power handling and minimal PowerCompression. The improved cooling also increases the durability and reliability of the subwoofer. Excellent dynamics and tight impulse fidelity paired with an extremely high sound pressure level are the results of many individual optimization processes.

A M20 threaded insert on the top of the housing allows the mounting of a distance rod. In addition, four abrasion resistant rubber feet on the underside and the associated cutouts on top ensure a secure stacking of same cabinets. The NL4 Speakon jacks, mounted on the back of the connector panel, are used to connect and link the input signal. The loudspeaker enclosure is available in the options RAL-Colours, outdoor and as installation version. The installation version (suffix i) eliminates the M20 flange, the transport handles and the stacking feet cutouts. Matching, padded and water-repellent transport sleeves are optionally available.



The **hd Slim265** is a passive design subwoofer equipped with two 6" woofers in bass reflex tuning. The ultra-compact dimensions enable inconspicuous and inconspicuous positioning of subwoofers on ceilings, walls or on the floor in small to medium-sized sound reinforcement tasks such as houses of worship, restaurants or conference rooms.

The hd Slim265 can be installed flexibly and easily with brackets on a wall or ceiling or can be used on the floor using the adjustable feet. Clamp connections on the loudspeaker side ensure that the loudspeaker can be connected quickly and without tools. The loudspeaker can be customized in all RAL-Colours for optimal adaptation to the room architecture. Due to the super flat design of only 102 mm, the hd Slim265 requires operation on Harmonic Design® system amplifiers for precise and unobtrusive bass reproduction. The impedance of 4 or 16 ohms, which can be selected when ordering, uses the available amplifier resources efficiently and in a budget-friendly manner.



hd Slim265
Design Subwoofer

hd B210

Installation Subwoofer



The **hd B210** is a compact passive installation subwoofer with bass reflex tuning. The bass system is equipped with two specially developed 10" long-throw chassis with 2.5" voice coil and single-roll bead and ventilated with a large, flow-optimized port. The inconspicuous, simple housing design with fine-meshed protective grille enables the loudspeaker to be placed inconspicuously in the room.

Key Features

- high performance loudspeaker
- extremely high sound pressure
- bass reflex tuning
- compact housing design
- versatile applications
- extended low frequency performance from 35 Hz
- flow-optimized ports

Applications

church, touring, rental companies, concert halls, discos, live music, sports arenas, DJ

Options

Weatherproof, RAL-Colour, installation version with-out handles and flange, 100 mm hd SilentWheels, protective transport cover, wheel board

Model	Type	Transducers	Impedance	Power Rating RMS / Peak	Sensitivity (1W / 1m)	SPLmax Half-space	Freq. Range (-6dB)	Weight	Dimensions W x H x D (mm)
Slim265	Subwoofer	2x 6"	4 / 16 Ω	300 / 600 W	98 dB	125 dB	55 Hz - 200 Hz	9 kg	400 x 102 x 584
B210	Subwoofer	2x 10"	4 Ω	600 / 1200 W	99 dB	133 dB	38 Hz - 150 Hz	22 kg	700 x 317 x 350
Sub12	Subwoofer	12"	8 Ω	400 / 800 W	98 dB	137 dB	40 Hz - 180 Hz	19 kg	400 x 430 x 420
Sub15	Subwoofer	15"	8 Ω	1000 / 4000 W	101 dB	139 dB	40 Hz - 130 Hz	31 kg	465 x 472 x 520
Sub18	Subwoofer	18"N	8 Ω	1800 / 7200 W	102 dB	143 dB	35 Hz - 110 Hz	40 kg	536 x 542 x 600
Sub21	Subwoofer	21"N	8 Ω	1800 / 7200 W	102 dB	143 dB	27 Hz - 110 Hz	60 kg	650 x 590 x 750



hd Infra212

Hybrid Subwoofer

The **hd Infra212** is a very flat, high-performance subwoofer for the precise reproduction of frequencies below 34 Hz. Exceptional power reserves with minimal distortion at the same time make the Infra212 a modern and flexible tool for touring and installation applications. Thanks to its compact dimensions with an extremely low overall height of only 366 mm, it can be easily placed under 40 cm stage platforms.

The hybrid horn construction with bass reflex tuning houses two special 12" high-performance chassis with 4" voice coil and a linear stroke of 25 mm. Thanks to their high power rating of up to 8,000 W, a maximum sound pressure of 143 dB can be achieved. The 12" chassis with low membrane inertia ensure a very dry bass reproduction, which makes the subwoofer a real problem solver for undefined and spongy basses for applications in rooms. The exceptionally large, flow-optimized bass reflex port, known from the hd Infra218, enables an enormous depth that would only be possible with significantly larger chassis and constructions.

Due to its high efficiency, the subwoofer can be perfectly combined for powerful mobile sub-sat systems with the hd MP-Series, in LineArray applications with the HybridLineSource and LineSourceArray systems or as space-saving DJ monitoring with the hd 12CXN. Two M20 threads allow horizontal and vertical operation with a spacer rod. A Speakon reversible socket in the protective grille enables cardioid subwoofer setups to be set up efficiently.

The **hd SilentWheels**, specially developed for the Harmonic Design® high-performance subwoofers, can be attached to the rear. These enable the subwoofer to operate noiselessly – without the usual rattling and vibrating of the rollers.



hd Infra218

Hybrid Subwoofer



A large, flow-optimized reflex port ensures excellent air stimulation with minimal turbulence and distortions. The frequency range from 24 Hz to 120 Hz makes them the perfect bass addition to all Harmonic Design® loudspeakers. Thanks to long range, high efficiency, and passive directivity, they integrate seamlessly into LineArray applications. Protective PVC runners and recesses ensure secure stacking, while a Speakon socket in the protective grille enables cardioid configurations without special cables.

Key Features

- high performance loudspeaker
- extremely high sound pressure
- long throw
- passive directivity pattern
- extended low frequency performance from 28 Hz
- improved cooling
- Speakon reversible socket
- M20 flange on two sides

The **hd Infra218** and **hd Infra221** are high-performance subwoofers with a hybrid housing design for reproducing frequencies below 24 Hz. Compact dimensions and exceptional power reserves with minimal distortion make them a flexible tool for touring and installation applications requiring extreme sound pressure in the lowest frequency band and maximum control over radiation behavior.



hd Infra221

Hybrid Subwoofer

Applications

Touring, rental companies, concert halls, discos, live music, sports arenas, DJ

Options

Weatherproof, RAL-Colour, installation version without handles and flange, 100 mm hd SilentWheels, protective transport cover, wheel board

Model	Type	Transducers	Impedance	Power Rating RMS / Peak	Sensitivity (1W / 1m)	SPLmax Half-space	Freq. Range (-6dB)	Weight	Dimensions W x H x D (mm)
Infra212	Hybrid	2x 12"	4 Ω	2000 / 8000 W	102 dB	143 dB	34 Hz - 160 Hz	54 kg	846 x 366 x 540
Infra218	Hybrid	2x 18"N	4 Ω	3600 / 14400 W	106 dB	149 dB	28 Hz - 120 Hz	89 kg	1190 x 536 x 670
Infra221	Hybrid	2x 21"N	4 Ω	3600 / 14400 W	106 dB	150 dB	24 Hz - 110 Hz	122 kg	1395 x 595 x 865

hd P-Series

Active System Subwoofer

The **hd P-Series** is acoustically identical to the hd Sub-Series with the difference that the hd P-Series contains the High-End hd MultiDSP and powerful Class-D amplifiers in the same enclosure and thus becomes a basic building block for any mobile plug & play system. The new DSP platform now enables all processing and control functions of large sound systems in easy-to-use plug & play active system. On the back panel there are LED metering indicators for each input and output channel, as well as an USB interface for setting and managing all audio parameters via PC. The extremely powerful DSP offers FIR- and IIR-filters for the exact adjustments and optimizations of the PA system to the respective application. The input section includes a routing matrix, a signal generator (sine and noise generator) and a freely configurable EQ per input channel with 16 IIR-filters and a 384 taps FIR-filter. There are 16 IIR-filters, 384 Taps FIR-filter, 100 ms delay, 180° phase reversal, Peak- and RMS Limiter, Gain and Mute available per output channel.



hd P12stereo
Active System Subwoofer



There are 20 factory presets for all Harmonic Design® speaker system configurations stored for direct recall on the device so that it can always be reset to a defined default state of the system. This guarantees the highest reliability of the connected speakers and ensures a very dynamic and linear sound.

Key Features

- 1x 12" Long-Excursion Subwoofer 400 W / 800 W
- transmission range from 40 Hz
- 3-channel Class-D amplifier (2x 500 W)
- high-End-DSP with FIR-/IIR-Filter
- multistage limiter architecture
- compact and lightweight enclosure
- ergonomic transport handles
- M20 flange

Applications

Conference rooms, multimedia applications, live music, A/V installations, mobile use

Options

RAL-Colour, install version without transport handles and flange, protective transport cover

for usage with

hd M-Series, hd ML-Series, hd C-Series

Model	Type	Transducers	Power Rating RMS / Peak	SPLmax Half-space	Freq. Range (-6dB)	DSP	Amplifier @ 4 Ω	Weight	Dimensions W x H x D (mm)
P12	active Subwoofer	12"	400 / 800 W	133 dB	40 Hz - 180 Hz	2in3	3x 500 W	19 kg	400 x 430 x 420

For user-specific settings, another 20 freely configurable user presets are available to save and manage individual system configurations. A highly readable 4-line LCD display with 3.2" screen size and 5 navigation buttons on the **hd P15** and **hd P18** enable easy and intuitive operation of all functions, as well as the loading of factory or user presets directly on the device without a PC. For reasons of space, the **hd P12stereo** has only full access through USB. This makes it possible to adapt the PA system to the changing requirements from day to day in the shortest possible time and makes the usual complete system change, for a small or large event, superfluous. In addition, the easy-to-use hd LevelZ PC remote software provides even more detailed possibilities of individual adjustments and an unlimited number of user presets and system configurations.



hd P15
Active System Subwoofer



The multi-channel Class-D amplifiers deliver up to 2500 W on a single output channel and are designed to meet the highest audio quality and reliability requirements in mobile applications. This is ensured by a SMPS power supply with Power Factor Correction (PFC), which, even under unfavorable power grid conditions, such as under overvoltage, thanks to a universal operating range of 85 V to 265 V, can provide full power at all times and is therefore far superior to conventional power supplies.



hd P18
Active System Subwoofer

Key Features

- long excursion speakers
- 3-channel Class-D amplifier (2500 W / 800 W / 800 W)
- high-End-DSP with FIR-/IIR-Filter
- multistage limiter architecture
- high SPL in a lightweight compact enclosure
- extended low frequency performance
- 3.2" LCD with navigation buttons and USB
- control of all features directly on the device without PC

Applications

Touring, concert halls, discos, live music, sports arenas, DJ, mobile use, hotels, A / V installations

Options

RAL-Colour, installation version without handles and flange, 100mm hd SilentWheels, wheel board, protective transport cover

for usage with

hd ML-Series, hd PL-Series, hd x81-Series, hd MP-Series

Model	Type	Transducers	Power Rating RMS / Peak	SPLmax Half-space	Freq. Range (-6dB)	DSP	Amplifier @ 4 Ω	Weight	Dimensions W x H x D (mm)
P15	active Subwoofer	15"	1000 / 4000 W	139 dB	40 Hz - 130 Hz	2in4	1x 2500 W + 2x 800 W	31 kg	465 x 472 x 520
P18	active Subwoofer	18"N	1800 / 7800 W	141 dB	35 Hz - 100 Hz	2in4	1x 2500 W + 2x 800 W	43 kg	536 x 542 x 600

hd Columns

Overview

Genuine 1-way design.

In order to transmit a sound event from the fundamental to the overtones, conventional loudspeakers use two or three different types of transducers. This results in incoherence not only in the crossover areas, but also in the important mid-frequency-range due to the different decay times and the different diaphragm mass of the transducers types in a different "response characteristic". Especially in the reproduction of instruments or speech, in which the fundamental range is covered by the one type of transducer and the overtone range by the other type of transducer, the sound is distorted. Here, the consistent 1-way design of the hd column speakers offers clear advantages: the full-range speakers, which reproduce the fundamental tone range up to the overtone range, combined with the arrangement as a PointSource or LineSource, makes the reproduction a first-class listening experience.

hd C-Series

Commercial Stick



- PointSource
- 2" fullrange and 3.5" coax speakers
- no DSP processing necessary: usage with any amplifier
- integrated frequency and phase optimized crossover
- coverage 100° x 50° and 80° x 80°
- 100V-version available
- passive

hd M-Series

PointSource Stick



- PointSource
- 2" fullrange speakers
- usage with system amplifier
- coverage 100° x 50°
- 100V-version available
- passive

hd ML-Series

LineSource Stick

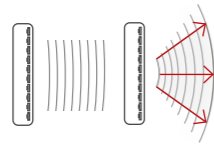

- LineSource
- 2" fullrange speakers
- usage with system amplifier
- coverage 100° x 20°
- 100V-version available
- passive or self-powered with hd Beamforming

hd PL-Series

PowerLine Stick

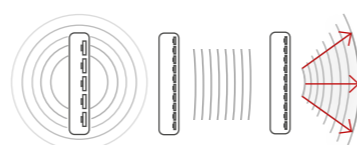

- LineSource
- 3" fullrange speakers
- usage with system amplifier
- coverage 80° x 15°
- passive or self-powered with hd Beamforming

Suitable for every situation.

The continuous U-slot for M6 square nuts on the back of the loudspeaker enables all brackets or a tiltable tripod adapter to be attached. For mobile use as a PA system, the use of the hd mounting adapter is recommended. Thus, the pan and tilt adapter can be easily attached and removed in seconds with two wing screws. M6 threads in the cover and base allow space-saving installation with L-brackets. A Speakon is located on the base plate for connection in mobile applications, while a connection block for fixed installations is located on the inside. There is an optional built-in pole mount underneath.

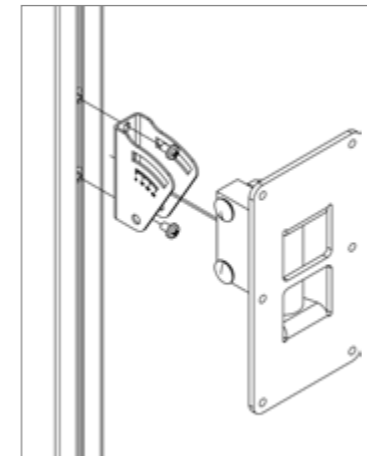

hd C-Series
2" fullrange / 3.5" coaxial

hd M-/ML-Series
2" fullrange

hd PL-Series
3" fullrange

Series	Type	Transducers	Coverage hor x ver	passiveXO	100V-version (optional)	RAL-Colour / Custom length	Ø (mm)
hd C-Series	PointSource	2" / 3.5" coaxial	100° x 50° / 80° x 80°	Yes	Yes	Yes	80 / 108
hd M-Series			100° x 50°	-	Yes		80
hd ML-Series	LineSource	3" fullrange	100° x 20°	-	Yes		80
hd PL-Series			80° x 15°	-	-		108

One design, four applications

Radiation characteristics make the difference

The columnar loudspeakers can be manufactured as a subwoofer, point source or line source. This offers the advantage that the right radiation characteristics can be used for the specific application. For example, for large distances or reverberant rooms, the main loudspeakers can be configured as a line sound source and for a shorter listening distance in secondary areas, point sound sources can be designed as loudspeakers with the same appearance. An ultimate, consistent sound is achieved thanks to the Harmonic Design® Beamforming loudspeakers.

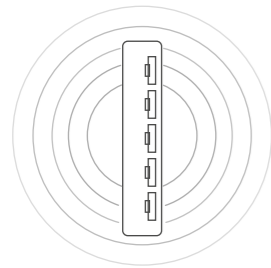

Subwoofer
spherical radiation,
high volume decrease



Point source
spherical radiation,
high volume decrease

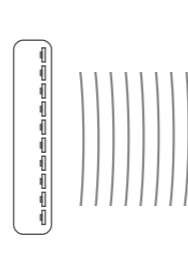

Line sound source
bundled radiation,
low volume decrease

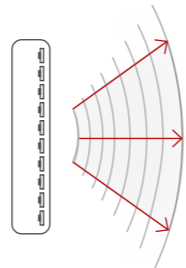

Harmonic Design® Beamforming
variably adjustable radiation,
low volume decrease

High-quality feel thanks to a variety of surfaces.

Choose the right version in smooth, fine structure, matt, pearl effect, metallic or your own degree of gloss.

Fantastic finish – perfectly coordinated.

Aluminium housing, cover and front grille with adapted acoustic foam available in all RAL classic colours. Other colour catalogues and surfaces possible on request.



Custom-made products as standard.

Thanks to flexible manufacturing processes, Harmonic Design® has been manufacturing all column loudspeakers with customer-specific lengths, colours, transducers or brackets for years and therefore ideal adapting them to your application environment – without long delivery times and high additional costs. Short distances thanks to Made in Germany. Because we know that this is exactly what counts. Of course, we offer a whole range of intelligent accessories so that most applications can be covered. And if not? Then contact us!



A perfect fit for any screen, column, protrusion or niche
The width and height of the loudspeakers are according to customer requirements. Made to measure up to 3 m – without long delivery times.

hd PLB

Subwoofer Stick

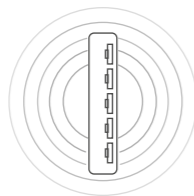

The **hd PLB** is an extremely compact, array-capable subwoofer in the elegant hd PL-Series column speaker design with astonishing bass reproduction for combination with any mid-high speaker for full-range applications. The inconspicuous hd PLB subwoofer element consists of ten powerful 3.5" long-throw chassis with a continuous power rating of 150 W RMS. Thanks to the proven single-roll bead technology for a large linear stroke and the best possible impulse fidelity, the 104 x 108 mm slim subwoofer has a frequency range of 40 - 160 Hz (-6 dB) and is therefore ideally suited for invisible applications in restaurants, conference rooms, museums, theaters or houses of worship. The nominal impedance is 6 Ω, so that various sound reinforcement scenarios can be efficiently implemented with the installation amplifiers of the hd Qi-Series.

The hd PLB subwoofer module has the same housing dimensions as the hd CCX and PL-Series and can be combined with the hd C5CX or hd PL16 to form an inconspicuous but dynamic full-range column loudspeaker with a transmission range of 40 - 22,000 Hz. If desired, this combination can also be produced in a continuous housing.



Mix+Match

Subwoofer + Top speakers

Unique combination option with a subwoofer and mid-high frequency unit in a common housing.

Your favorite mid-high range loudspeaker in the elegant pillar design has additional subwoofers to reproduce the entire frequency spectrum dynamically and at the same time inconspicuously. For example, the loudspeaker visually extends to the height of the room in order to fit seamlessly into the architecture. The tweeters are installed at the ideal height.

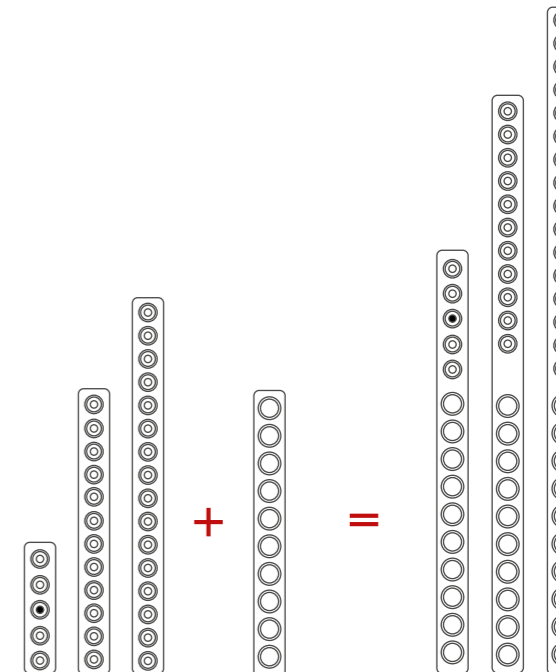

Key Features

- Subwoofer in column design
- amazing reproduction from 40 Hz high sound pressure up to 115 dB
- weatherproof aluminium housing
- subtle room integration
- 100V-version available
- custom-made products possible

Applications

Restaurants, bars, airports, stations, conference rooms, hotels, A/V installations, multimedia applications, congress rooms, TV studios, houses of worship, concert halls, broadcast

Options

RAL-Colour, various mounting and connection solutions, 100V-version, custom length

Model	Type	Transducers	Impedance	Power Rating RMS / Peak	Sensitivity (1W / 1m)	SPLmax Half-space	Freq. Range (-6dB)	Weight	Dimensions W x H x D (mm)
PLB	Subwoofer	6x 3.5" + 4x 3.5" PR	6 Ω	150 / 300 W	83 dB	115 dB	40 Hz - 160 Hz	6 kg	108 x 1029 x 104



hd C-Series

Commercial Stick



The **hd C-Series** is a product family of commercial design loudspeakers that deliver affordable and excellent performance for music and voice applications, such as in retail stores, public facilities, restaurants, A/V installations, or mobile applications. Equipped with high-end hd drivers, the hd C-Series can be used with any third-party device such as A/V receivers, media control units or multi-channel amplifiers, making system integration easy. The lightweight, stylish and ultra-compact column speakers can be mounted on the ceiling, on the wall or on various stands, and are available in custom colour schemes as well as custom-sized enclosures to match every screen size or architectural demand. They consist of the **hd C2**, **hd C4** and **hd C8** featuring the hd true 1-way point source column speaker design ranging from two to eight 2" fullrange drivers. The family members **hd C1CX**, **hd C3CX**, **hd C5CX** and **hd C7CX** feature a D'Appolito design with a centrally placed coaxial 3.5" high-excursion cone driver with tweeter surrounded by up to seven 3" woofers. A passive frequency- and phase-optimized crossover is integrated into the aluminium housing and ensures a smooth and natural reproduction behaviour in the entire dispersion pattern with any drive unit.

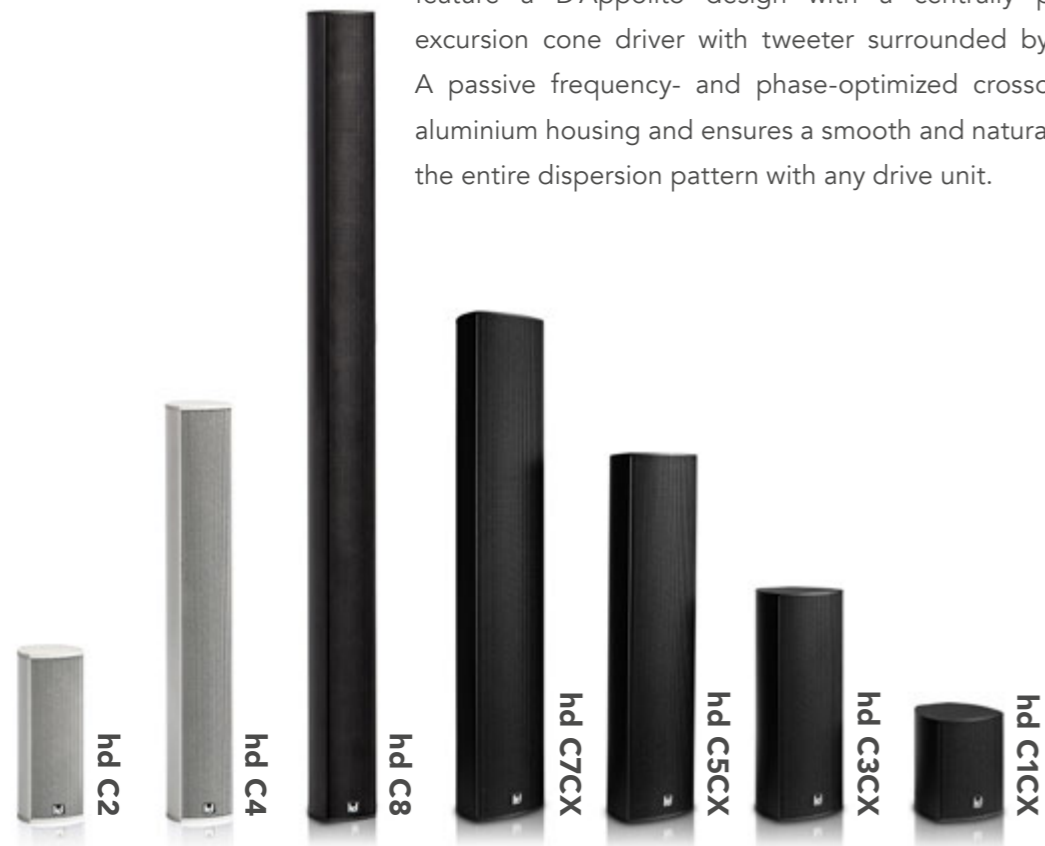

Extremely powerful subwoofers from the hd Sub- or P-Series with up to 1800 W AES power handling extend the low frequency sound experience down to the subsonic range. The most elegant solution for extending the low frequency range of the hd C-Series is the super slim **hd Slim265** design subwoofer. Due to its low construction height of only 102 mm, the hd Slim265 fits into any suspended ceiling and can be mounted on a wall or placed invisibly under furniture. The hd PLB can be combined with the CCX-Series using Mix & Match.



The hd C-Series can be flexibly and easily installed and mounted. The loudspeaker can be optimally aligned with the inconspicuous spherical joint wall mount or with minimal space requirements with L-brackets and two M6 threads top and bottom. If wall mounting is not possible, the speakers can be used with a 3/8" thread on the bottom plate on an elegant designer stand or microphone stand.

Applications in existing or newly designed distributed systems can be realized with the optional 100V-versions. Up-to-date transformers guarantee great audio performance even over long distances and with small cable cross-sections. Multiple power taps make any adjustments to the sound level possible.

Key Features

- usable with standard amplifiers
- frequency- and phase-optimized crossover
- elegant design
- precise and smooth coverage
- radiation pattern 100° x 50°
- superb speech intelligibility
- inconspicuous integration into architecture
- 100V-version available

Applications

Airports, stations, distributed systems, conference rooms, A/V Installations, home cinema, multimedia applications, broadcast, congress rooms, hotels

Options

RAL-Colour, various mounting solutions, 100V-version, custom length

Model	Type	Transducers	Impedance	Power Rating RMS / Peak	Sensitivity (1W / 1m)	SPLmax	Freq. Range (-6dB)	Weight	Dimensions W x H x D (mm)
C1CX	80° x 80°	1x 3.5" Coax	8 Ω	40 / 55 W	89 dB	111 dB	120 Hz - 22 kHz	1 kg	108 x 120 x 104
C2	100° x 50°	2x 2"	8 Ω	50 / 70 W	89 dB	113 dB	150 Hz - 22 kHz	2 kg	80 x 205 x 78
C3CX	80° x 80°	3.5" Coax + 2x 3"	4 / 8 Ω	115 / 160 W	90 dB	112 dB	100 Hz - 22 kHz	2 kg	108 x 280 x 104
C4	100° x 50°	4x 2"	4 / 16 Ω	100 / 140 W	92 dB	116 dB	120 Hz - 22 kHz	4 kg	80 x 545 x 78
C5CX	80° x 80°	3.5" Coax + 4x 3"	8 Ω	190 / 265 W	91 dB	115 dB	90 Hz - 22 kHz	4 kg	108 x 460 x 104
C7CX	80° x 80°	3.5" Coax + 6x 3"	8 Ω	265 / 340 W	93 dB	118 dB	80 Hz - 22 kHz	7 kg	108 x 640 x 104
C8	100° x 50°	8x 2"	8 / 32 Ω	200 / 280 W	95 dB	119 dB	90 Hz - 22 kHz	6 kg	80 x 1005 x 78

hd M-Series

PointSource Stick



The **hd M-Series** are design column speakers with PointSource wave radiation characteristics. The elegant housings are made out of strength aluminium to prevent resonances in the audible frequency range. They are available in various surface structures, such as powder coated, anodized or varnished in RAL-Colours. This guarantees an unobtrusive integration into any existing spatial architecture of houses of worship, conference rooms or theatres.

The hd M-Series consists of the ultra compact **hd M2**, with two 2" drivers, which is ideally suited for near field or voice applications, the slightly larger **hd M4** for example as a fill loudspeaker in church and the **hd M8** as a very compact main loudspeaker in conference or music applications. The number of integrated speakers is easily detectable in the product's suffix and allows quick classification of the size, application and power capacity for the end-user and planner. The difference between the the hd M- and hd ML-Series is the vertical beam angle and the wave propagation characteristics. Whenever large vertical dispersion is required and the throw is secondary, then the hd M-Series is the right choice, using the same drivers and the same outer appearance as the hd ML-Series.

All loudspeakers can be used in distributed high voltage applications with the 100V-option. Up-to-date transformers guarantee great audio performance even over long distances and with small cable crosssections. Multiple power taps speaker allow you to adjust the volume. External processing is required.

For superior and linear reproduction of a sound event from the fundamental to the highest audible frequencies, conventional loudspeakers must use different types of drivers to reproduce the entire frequency range. The result is incoherence and phase shifts in the mid frequency range due to different diaphragm masses, varying transient behaviours and decay times of the different sized drivers. According to the true 1-way design, the hd M-Series is free of interference in the important mid-range because there are no phase shifts as each speaker has the same signal and characteristics. The result is an outstanding sound quality in music and speech, enhanced dynamics and even coverage of audience areas.

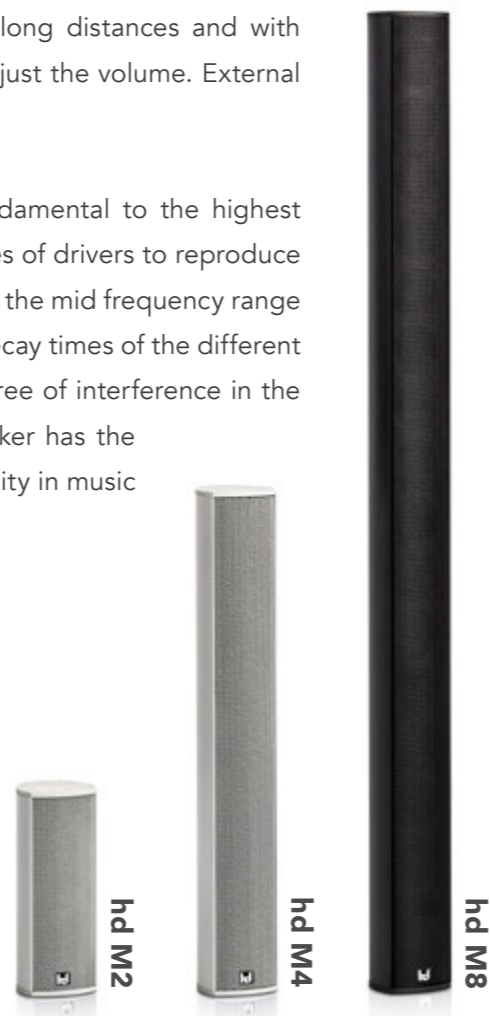

Various mounting solutions are available with the full-length U-slot on the back of the column speaker. M6 square nuts can be inserted easily to use tilt and swivel wall mounts or stand adaptors for fixed installations or mobile use. A Neutrik NL4MP Speakon is located on the bottom plate for input connection in mobile applications, while a terminal block for fixed installations is located inside. On the bottom there is an optional built-in pole flange. The protective design grille with deposited acoustic foam is also available in the same finish as the housings to ensure perfect protection against splash water or damage and unobtrusive integration into any room architecture. The hd M-Series is also available in custom lengths to fulfill all project requirements.

Secure flown applications are possible with an optional clamp or halfcoupler for mounting on the loudspeaker column. Robust padded transport bags or lightweight double-cases with wheels provide adequate protection during transport.



Key Features

- point source characteristics
- elegant design
- precise and smooth coverage
- radiation pattern 100° x 50°
- superb speech intelligibility
- inconspicuous integration into architecture
- custom sizes available
- 100V-version available

Applications

Conference rooms, houses of worship, concert halls, live music, broadcast, A/V installations

Options

RAL-Colour, various mounting and connection solutions, 100V-version, custom length, transport bag

suggested subwoofers

hd Slim265, hd PLB, hd B210, hd Sub12, hd P12stereo, hd Sub15, hd P15

Model	Type	Transducers	Impedance	Power Rating RMS / Peak	Sensitivity (1W / 1m)	SPLmax	Freq. Range (-6dB)	Weight	Dimensions W x H x D (mm)
M2	PointSource	2x 2"	8 Ω	50 / 70 W	89 dB	113 dB	170 Hz - 20 kHz	2 kg	80 x 205 x 78
M4	PointSource	4x 2"	4 / 16 Ω	100 / 140 W	92 dB	116 dB	150 Hz - 20 kHz	3 kg	80 x 553 x 78
M8	PointSource	8x 2"	8 / 32 Ω	200 / 280 W	95 dB	119 dB	130 Hz - 20 kHz	5 kg	80 x 1000 x 78



hd ML-Series

LineArray Stick

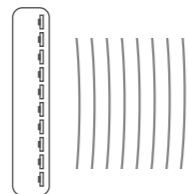

The **hd ML-Series** is a product family of very compact LineArray Sticks designed specifically for high-quality music and speech reproduction. The lightweight and elegant speakers can be set up and installed within seconds. A perfect integration into the existing room architecture or stage design is achieved by the slim and stylish design of the column speakers and therefore makes the hd ML-Series the first choice of system integrators, event organizers, agencies, musicians and audiences.

The hd ML-Series consists of the **hd ML8**, **hd ML16**, **hd ML24** and **hd ML32** as passive column loudspeakers. Due to the modular design of the hd ML-Series, it is possible to realize customer-specific lengths and assemblies for optimum adaptation to the respective requirements. The 2" broadband drivers which are specially produced for the hd ML-Series produce a wave front with accurate cylindrical dispersion characteristics in the whole operating frequency range and up to the highest audible frequencies. The resulting longer throw distance and better speech intelligibility compared to conventional column loudspeakers predestines the hd ML-Series LineArray Sticks for use in acoustically difficult environments such as houses of worship, airports or halls. The long throw of up to 35 m and smooth horizontal coverage of 100° makes the hd ML-Series an inconspicuous and powerful loudspeaker for superior audio environments with only few speakers. The 2" chassis, with their small diaphragm weight and almost the same size as human vocal cords, are the best choice for reproducing the human voice in the most difficult applications such as houses of worship, conference rooms, airports, train stations and live music.

The hd ML-Series is also available with the implementation of the hd Beamforming-Technology. The hd MLBeam-Series are self-powered, digitally steered column speakers with integrated High-End-DSP and powerful multi-channel amplifiers. Extensive beamforming algorithms are applied to shape the sound where it belongs and to take control of all acoustical parameters.

Due to the true 1-way design, the ML-Series is free of interference in the important mid frequency range because there are no phase shifts in a crossover that typical 2-way systems have. The result is outstanding sound quality in music and speech, enhanced dynamics and even coverage of the listening areas. The hd ML-Series is fully compatible with the Harmonic Design® system concept and can be perfectly combined with the active subwoofers hd P12, hd P15 and hd P18 or Harmonic Design® System amplifiers.



The **hd MLC** cardioid expansion module is available for demanding applications in mobile and permanent installations, effectively reducing the backward radiated frequency components by up to 20 dB. The further optimized directivity of the column speaker by the cardioid module thus considerably reduces the feedback susceptibility in the low-mid range and at the same time improves speech intelligibility, since no sound energy is radiated diffusely into unwanted areas. The hd MLC module is mounted directly on the back of the hd LineArray Stick and driven by a separate amplifier channel. Cardioid or hypercardioid characteristics can be easily retrieved using the corresponding DSP preset via the hd LevelZ software. In addition to the reduction of the back radiated sound energy, the hd MLC cardioid module also extends the SPL capabilities in the low-mid range of the hd ML-Series towards the audience. This makes the sound even more punchy and dynamic with the same line length.

All loudspeakers can be used in distributed high voltage applications with the 100V-option. Various mounting solutions are available with the full-length U-slot on the back of the column speaker. M6 square nuts can be inserted easily to use tilt and swivel wall mounts or stand adaptors for fixed installations or mobile use.

Key Features

- passive LineArray Stick
- cylindrical wave propagation
- perfect sound & excellent dynamics
- wide coverage 100° x 15°
- superb speech intelligibility
- best integration into room architecture
- custom sizes available
- 100V-version available

Applications

Live music, DJ, broadcast, conference rooms, hotels, airports, stations, houses of worship, concert halls

Options

RAL-Colour, various mounting and connection solutions, 100V-version, custom length, transport bag, self-powered Beamforming speakers (hd Beam-Series)

suggested Subwoofer

hd Sub-Series

Model	Type	Transducers	Impedance	Power Rating RMS / Peak	Sensitivity (1W / 1m)	SPLmax	Freq. Range (-6dB)	Weight	Dimensions W x H x D (mm)
ML8	LineArray Stick	8x 2"	8 Ω	200 / 280 W	89 dB	119 dB	160 Hz - 20 kHz	4 kg	80 x 553 x 78
ML16	LineArray Stick	16x 2"	4 Ω	400 / 560 W	92 dB	123 dB	140 Hz - 20 kHz	6 kg	80 x 1000 x 78
ML24	LineArray Stick	24x 2"	6 Ω	600 / 840 W	95 dB	125 dB	120 Hz - 20 kHz	8 kg	80 x 1513 x 78
ML32	LineArray Stick	32x 2"	8 Ω	800 / 1120 W	96 dB	127 dB	90 Hz - 20 kHz	10 kg	80 x 1958 x 78
MLC	Cardioid Add-On	9 x 2"	4 Ω	225 / 315 W	89 dB	117 dB	80 Hz - 500 Hz	5 kg	80 x 708 x 78

hd PL-Series

PowerLine Stick

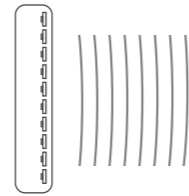

The **hd PL-Series** extends the Harmonic Design® LineArray Stick portfolio with a more powerful PowerLine Stick loudspeaker series. The elegant design introduced by the hd ML-Series has been transferred to a slightly larger column speaker series. Lightweight and highly stiff aluminium enclosures, paired with groundbreaking newly developed 3" drivers, provide high reliability and performance. The true 1-way design delivers superb natural sound reproduction of music and speech in reference studio monitor quality. For mobile applications, the elegant PowerLine Sticks can be combined with active system subwoofers of the hd P-Series with their open system architecture to create an elegant and high-performance PA system. With the modular design of each Harmonic Design® column loudspeaker series, custom lengths and colour schemes are available to meet the needs of any permanent installation project. A perfect integration into existing space architecture and stage scenery due to the remarkable size-to-performance-ratio makes the hd PL-Series the first choice of architects, system integrators and rental companies around the world.

The **hd PL12**, **hd PL16** and **hd PL24** are the standard models of the hd PL-Series. Equipped with high-performance hd 3" broadband drivers, the hd PL-Series produces a coherent sound field with cylindrical wave propagation. Extensive research and use of new materials was required to increase the frequency range to the highest audible frequencies with fullrange speakers that do not require additional tweeters. The 1-way design improvements provide a longer, coherent throw range with less loss of level and frequency over distance at the same time. Cylindrical wave propagation provides better speech intelligibility compared to other column loudspeakers and predestines the PowerLine Stick hd PL-Series for use in difficult acoustic environments such as houses of worship, train stations, airports or concert halls, where clarity, performance and an unobtrusive appearance are required.

The hd PL-Series is also available with the implementation of the hd Beamforming-Technology. The hd PLBeam-Series are self-powered, digitally steered column speakers with integrated High-End-DSP and powerful multi-channel amplifiers. Extensive beamforming algorithms are applied to shape the sound where it belongs and to take control of all acoustical parameters.

The **hd PLC** cardioid expansion module is available for demanding applications in mobile and permanent installations, effectively reducing the backward radiated frequency components by up to 20 dB. The further optimized directivity of the column speaker by the cardioid module thus considerably reduces the feedback susceptibility in the low-mid range and at the same time improves speech intelligibility, since no sound energy is radiated diffusely into unwanted areas. The hd PLC module is mounted directly on the back of the hd PowerLine Stick and driven by a separate amplifier channel. Cardioid or hypercardioid characteristics can be easily retrieved using the corresponding DSP preset via the hd LevelZ software. In addition to the reduction of the back radiated sound energy, the hd PLC cardioid module also extends the SPL capabilities in the low-mid range of the hd PL-Series towards the audience. This makes the sound even more punchy and dynamic with the same line length.

The through-going U-slot for M6 square nuts on the back allows it to be attached all brackets or a tiltable tripod adapter. A Speakon is located on the base plate for connection in mobile applications, while a connection block for fixed installations is located inside.

Key Features

- cylindrical wave propagation
- elegant design
- perfect sound & excellent dynamics
- high sound pressure
- wide coverage 80° x 10°
- superb speech intelligibility
- best integration into room architecture
- custom sizes available
- 100V-version available

Applications

Live music, DJ, houses of worship, museums, conference rooms, hotels, airports, stations, concert halls, broadcast

Options

RAL-Colours, various mounting and connection solutions, 100V-version, custom length e.g. PL32, PL40 self-powered Beamforming speakers (hd Beam-Series)

suggested Subwoofer

hd Sub-Series, hd P-Series

Model	Type	Transducers	Impedance	Power Rating RMS / Peak	Sensitivity (1W / 1m)	SPLmax	Freq. Range (-6dB)	Weight	Dimensions W x H x D (mm)
PL12	PowerLine Stick	12x 3"	6 Ω	450 / 630 W	94 dB	124 dB	130 Hz - 18 kHz	9 kg	108 x 1029 x 104
PL16	PowerLine Stick	16x 3"	4 Ω	600 / 840 W	96 dB	127 dB	110 Hz - 18 kHz	11 kg	108 x 1353 x 104
PL24	PowerLine Stick	24x 3"	6 Ω	900 / 1260 W	97 dB	128 dB	80 Hz - 18 kHz	15 kg	108 x 2001 x 104
PLC	Cardioid Add-On	9x 3"	4 Ω	340 / 470 W	93 dB	120 dB	70 Hz - 500 Hz	7 kg	108 x 878 x 104

hd PL16
PowerLine Stick

Harmonic Design® Beamforming Technology

Overview

Harmonic Design® Beamforming loudspeakers offer great potential for improving sound distribution in complex architectures and highly reverberant rooms. The goal is to focus the sound only on the auditory surfaces, while shading surfaces that cause unwanted reflections and produce disturbing diffuse sound should be shaded. This leads to a much better speech intelligibility and a first-class listening experience in speech and music performances for each listener and allows for an unobtrusive positioning of the speakers in previously unsuitable positions, as well as a flexible adaptation of the speaker radiation characteristics to different applications.

Compact design.

The ultra-compact width of just 80 mm makes the hd ML-Series the narrowest beamforming speaker available, which is almost invisible in permanent installations. The elegantly designed aluminium enclosure and the finely woven steel grille with premium powder coating seamlessly integrate the sleek, unobtrusive look of the column speakers into the room architecture, inspiring planners, architects, system integrators, event organizers and the audience.

Genuine 1-way design.

For excellent and linear reproduction of a sound event from the lowest to the highest audible frequency, conventional loudspeakers must use different types of drivers to reproduce the entire frequency range. The result is incoherence and phase shifts in the middle frequency range due to different membrane mass, varying transient response and decay time speakers of different sizes have. The hd column loudspeakers of the hd ML- and PL-Series are exclusively equipped with full-range loudspeakers and are thus trouble-free in the important mid-frequency range, as each loudspeaker has the same response and characteristics. The result is excellent sound quality for speech and music, improved dynamics and consistent horizontal coverage of the listening areas.

Cost efficient.

With our Beamforming Technology, we offer a completely new price-performance ratio. This allows the use of the technology for projects that would require influencing the sound beams, but have so far exceeded the budget. Our own in-house developed and manufactured components, algorithms and the planning software guarantee cost efficiency.

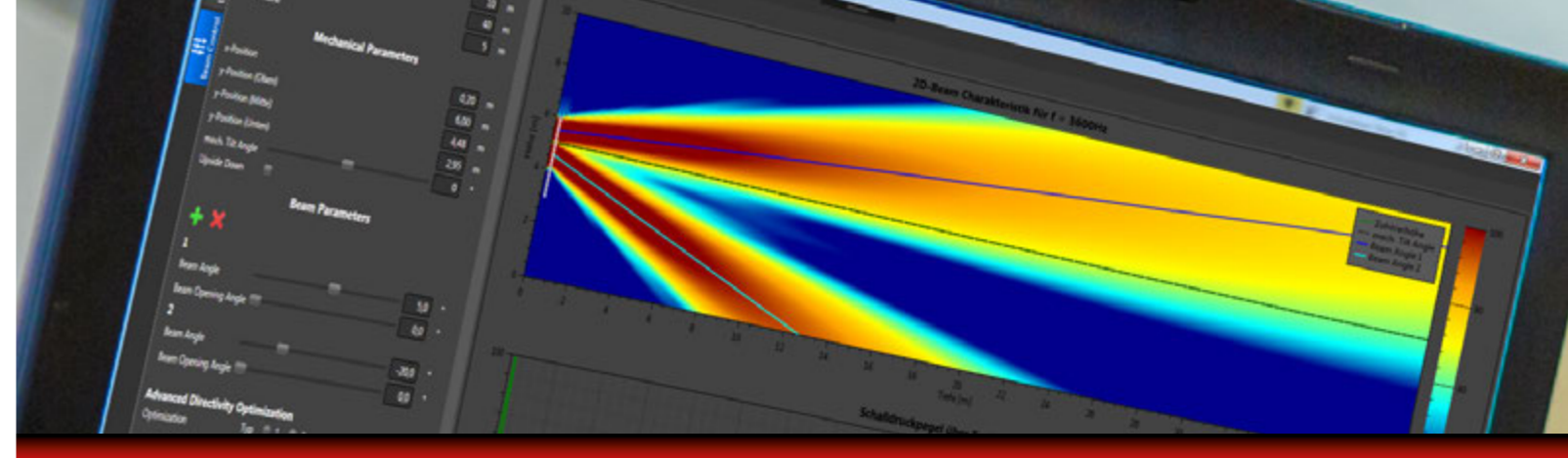

Scalable and customizable.

The modular concept of the hd ML-/PL-Series continues in the Beam-Series. Up to 32 DSP/amplifier channels, scalable in segments of 8, individual length and RAL-Colours, seamlessly integrate the speaker into the architecture – not the other way around. The standard colours are black (RAL 9005) and white (RAL 9010) without surcharge. The continuous U-slot on the back of the aluminium profile allows the use of M6 square nuts to attach a wall mount adapter or the use of the hd mounting adapter for quick and easy mounting of the tilt and swivel stand adapter for mobile applications. Top and bottom M6 threads allow wall mounting with minimal space requirements using the accessories L-brackets. The electronic unit is integrated into the housing of the loudspeaker and is optimally protected by the continuous finestructured design grid with backed acoustic foam and ensures an inconspicuous integration into any room architecture.

Dante® spoken here.

The Harmonic Design® Beamforming loudspeaker are prepared for digital audio transmission with Dante® audio streams from mixers or matrix systems, for example. This allows digital streaming of audio packets over a Dante® network directly and without additional DA/AD conversion to the integrated DSP core and amplifiers. A software-controlled redundant input selector switch for the analogue secondary input ensures fail-safety if required. If no digital transmission is required, both analogue inputs (primary and secondary) can be used to create an analogue fallback strategy.

Way-Beyond spatial aliasing.

The selection of 2" and 3" full-range chassis enables the shifting of the inevitable spatial aliasing from linear loudspeaker arrays to the highest frequencies. Due to the increasing directivity of the speakers, this phenomenon is also suppressed. The motivation to keep the speaker diameter to a minimum has increased the challenges for our research and development department in terms of the size of multi-channel amplifiers and DSP platforms, but was a necessary step to ensure the musicality of the beam-formed speaker array.



Multi-Channel DSP architecture.

Based on the enormous computing power of our hd MultiDSP, a new multi-channel DSP architecture has been developed that meets the high demands of beamforming algorithms. Each of the up to 32 output channels as well as user channel features a 384 Taps FIR filter and 16x IIR filters in double precision. The all-new hd BeamDSP performs over 300 million instructions per second to meet real-time criteria and provide enough freedom to shape the sound as needed.

Powerful amplifiers.

Each loudspeaker chassis is equipped with a DSP channel and a digitally interfaced and microprocessor controlled state-of-the-art Class-D amplifier. This guarantees best SNR for all gain settings and the possibility to surveil the impedance of each chassis and report its status in case of any fault. Each amplifier channel can deliver up to 75 watts into 4 Ω loads, delivering uncompromising audio with premium dynamics and headroom.

Harmonic Design® Beamforming Key Features

- 2In/32Out High-End hd BeamDSP
- redundant input selecti on fallback algorithm
- analogue + digital inputs with Dante®*
- AdvancedDirectivityOptimization algorithm
- 384 Taps FIR-Filter each Input/Output
- 16x IIR-Filter (double precision) each Input/Output
- modular equipping in segments of 8
- 75W Class-D amplifiers with digital input for best SNR
- ImpedanceControl with fault detection
- multi-stage Limiter-Architecture (Peak/RMS/Thermal)
- hd LevelZ Remote Software via TCP/IP
- standard colours: black RAL 9005 & white RAL 9010

Applications

- airports
- stations
- lecture halls
- houses of worship
- museums
- conference rooms
- hotels
- sport arenas
- A/V installations
- live events
- mobile use
- broadcast

*Dante® optional

hd Beam-Series

Beamforming Stick

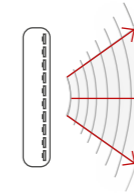

Key Features

- shielded fullrange chassis
- standard colours: RAL 9005 & RAL 9010
- smallest footprint starting at 80 mm width
- perfect sound & excellent dynamics
- wide horizontal coverage
- superb speech intelligibility
- best integration into room architecture
- HiFi-Sound

Options

RAL-Colour, custom size, various mounting solutions: tilt & swivel adaptor, L-brackets

suggested Subwoofer

hd Slim265, hd Sub-Series, hd P-Series

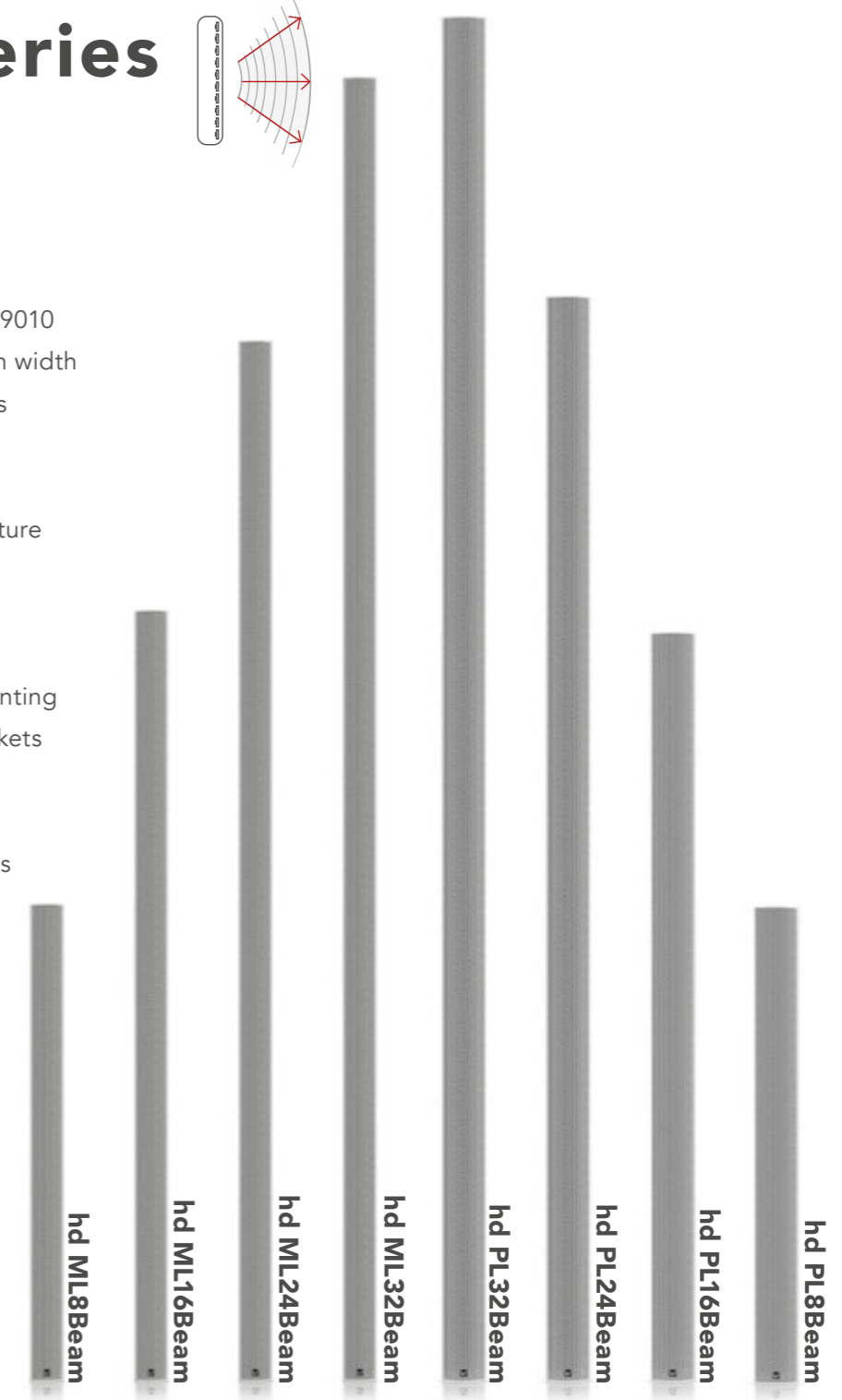

Model	Transducers	max. Beam Count	Amplifier	SPLmax	Freq. Range (-6dB)	Connections	Weight	Dimensions W x H x D (mm)
ML8Beam	8x 2"	1	8x 75W	119 dB	160 Hz - 20 kHz	Phoenix 3-pol Netz Phoenix 6-pol Audio Phoenix 6-pol GPIO Dante® Ethernet* remote Ethernet	5 kg	80 x 1070 x 78
ML16Beam	16x 2"	2	16x 75W	123 dB	140 Hz - 20 kHz		8 kg	80 x 1650 x 78
ML24Beam	24x 2"	3	24x 75W	125 dB	110 Hz - 20 kHz		12 kg	80 x 2190 x 78
ML32Beam	32x 2"	4	32x 75W	127 dB	90 Hz - 20 kHz		16 kg	80 x 2740 x 78
PL8Beam	8x 3"	1	8x 75W	123 dB	130 Hz - 20 kHz		10 kg	108 x 1029 x 104
PL16Beam	16x 3"	2	16x 75W	126 dB	110 Hz - 20 kHz		18 kg	108 x 1730 x 104
PL24Beam	24x 3"	3	24x 75W	127 dB	90 Hz - 20 kHz		23 kg	108 x 2450 x 104
PL32Beam	32x 3"	4	32x 75W	129 dB	70 Hz - 20 kHz		*optional	29 kg

Shape your Sound!

BeamControlParameter

Beam Steering.

Beam steering is the basic discipline of beam forming where the main lobe is digitally steered up- or downwards. Harmonic Design® Beamforming loudspeakers are capable to adjust the vertically main lobe beam angle up to $\pm 60^\circ$ with an accuracy of $0.1^\circ/\text{step}$.

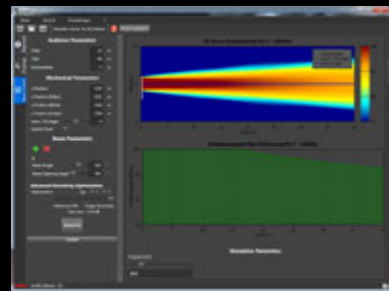

main beam @ 0°

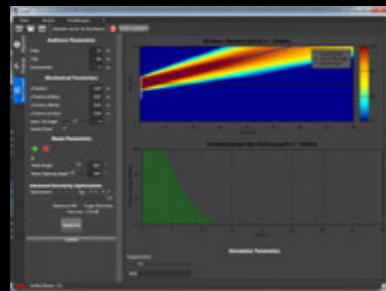

main beam @ $+10^\circ$

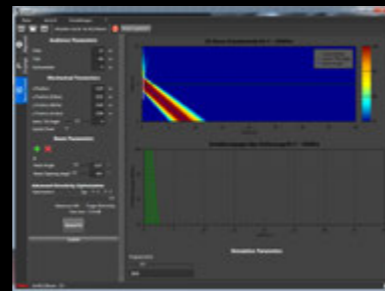

main beam @ -32°

Frequency independent opening angle.

Conventional loudspeaker arrays increase their directivity with increasing frequency resulting in a wide main lobe at low frequencies and a narrow main lobe at high frequencies. A frequency independent opening angle preserves the same opening angle over a great bandwidth within physical limitations and is adjustable from minimum to 90° in 0.1° steps. This guarantees perfect concentration of sound where it belongs and where not.

f = 800 Hz

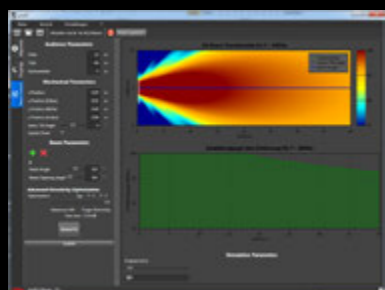

f = 2 kHz

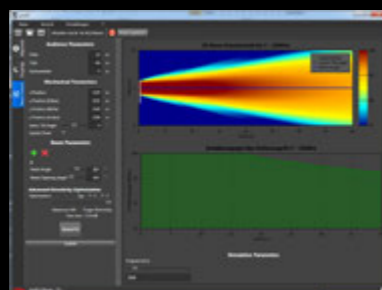

f = 4 kHz

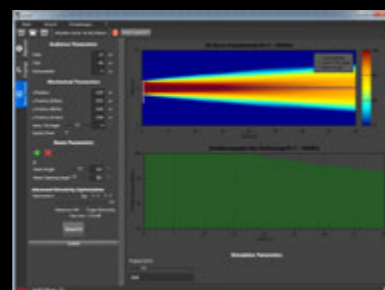

conventional main beam

frequency independent opening angle $\theta = 30^\circ$

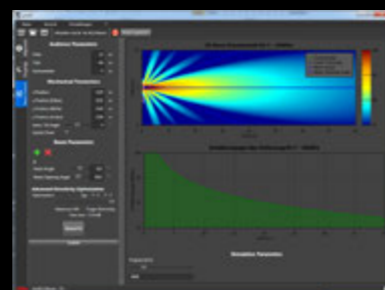
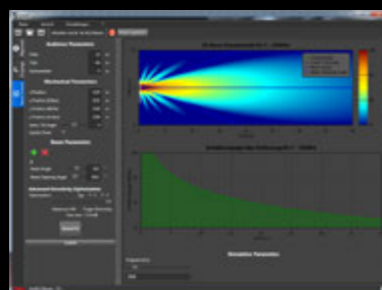
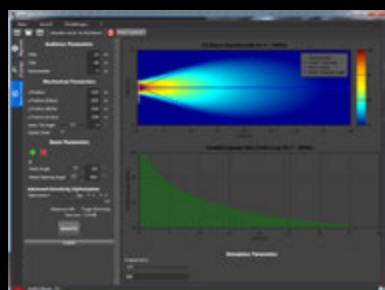

Multiple Beams.

The unique Harmonic Design® Algorithm enables up to 4 separate main beams that can be steered individually and still create a specific frequency independent opening angle.

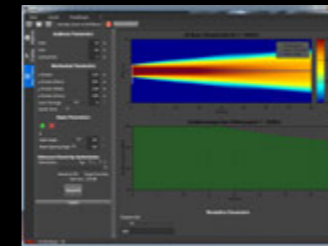

main beam @ 0°

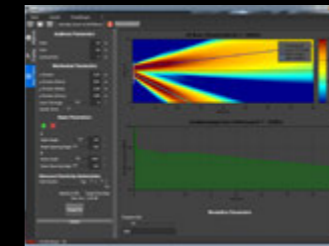

2 beams @ $+5^\circ|-20^\circ$

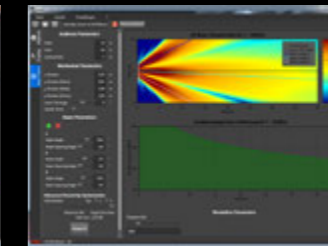

3 beams @ $+20^\circ|-2^\circ|-20^\circ$

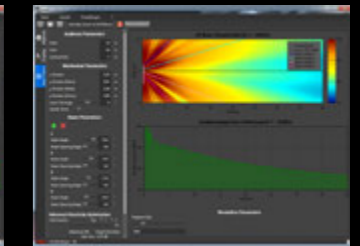

4 beams @ $35^\circ|12^\circ|-12^\circ|-35^\circ$

Advanced Directivity Optimization.

The conventional beam radiation pattern also contains unwanted side lobes that excite the auditorium with disturbing noise while declining speech intelligibility. By applying special algorithms to the individual DSP channels, an almost optimum, light-beam-like main lobe beam is achievable with an accurate side lobe suppression. The enhancements to improve speech intelligibility in reverberant rooms by applying ADO algorithm are extreme. The strength of the optimization tool may be adjusted by the end-user either towards maximum SPL or optimum target directivity.

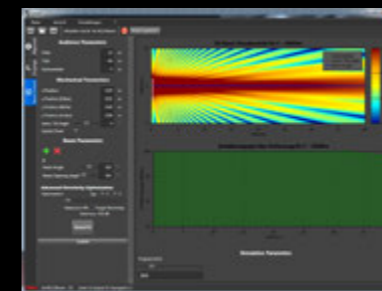

conventional beam pattern, ADO off

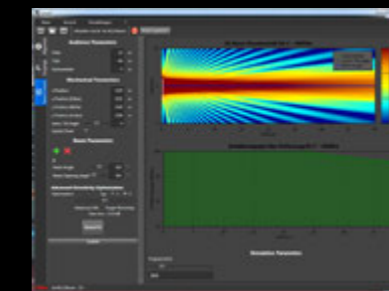

intermediate ADO

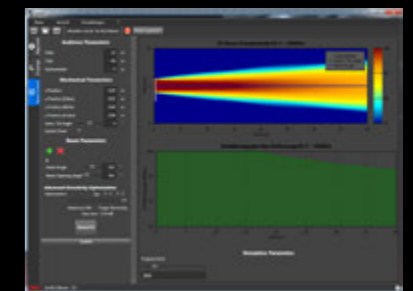

maximum ADO

Focus.

By default the focus point of the wave fronts of the individual loudspeakers is infinity and creates parallel running pressure waves. At the distance infinity all wave fronts are perfectly correlated and coherent, meaning they arrive at the same time with the same relative phase. Whenever this large throw is not necessary, it may be useful to focus the wave fronts on the front rows in steps of 0.1 m to tighten the "sweet spot".



hd CXN-Series

Coaxial Loudspeaker

The **hd CXN** Series is a 2-way passive system featuring neodymium bass-reflex midrange and tweeter drivers with linear tuning. They can be driven by any power amplifier, even without DSP. The **hd 6CXN**, **hd 8CXN**, and **hd 10CXN** are ideal for high-quality mobile or fixed installation sound reinforcement applications.

The conical horn provides a natural sound dispersion of 80° x 80° without coloration, long throw, and optimum speech intelligibility. The frequency- and phase-optimized crossover ensures a linear frequency response. An integrated 35 mm flange allows the use on a tripod or with two monitor angles of 35° and 45° as a stage monitor. The cabinet is made of multiplex plywood with a polyurethane coating and a black steel grille. It has multiple inlet threads for mounting.



hd 6CXN
Coaxial Loudspeaker



hd 8CXN
Coaxial Loudspeaker



hd 10CXN
Coaxial Loudspeaker

The **hd 181** is a passive 2-way system equipped with an 8" woofer in a vented design and a 1" neodymium high frequency driver coupled to an elliptical horn. Operation is possible via any power amplifier – even without a DSP – and makes the hd 181 the perfect solution for high-quality mobile or permanently installed public address applications in, for example, industrial events, theaters or sports facilities.

The housing is made of marine plywood and provided with a shock- and weather-resistant polyurethane coating, and a ballproof, elegant and rounded steel grille in black. The hd 181 can be flown safely or tilted on a tripod with the help of the optional U-bracket or simply straight with the integrated tripod mount. For permanent installation, several M8 inlet threads are available for the cost-effective installation of standardized wall brackets. The elliptical horn provides a natural sound without the horn-typical sound coloration, long throw and high speech intelligibility. The frequency- and phase-optimized crossover guarantees a linear transmission behavior.



hd 181
Universal loudspeaker



Key Features

- usable without DSP
- frequency and phase response optimized crossover
- conical coverage pattern
- lightweight compact enclosure
- HiFi-sound
- superb speech intelligibility
- fullrange sound
- elegant design

Applications

Rental companies, concert halls, mobile use, discos, broadcast, sports arenas , A/V installations

Options

RAL-Colour, various mounting options, outdoor, transport cover

suggested Subwoofer

hd Sub-Series, hd P-Series

Model	Type	Transducers	Impedance	Power Rating RMS / Peak	Sensitivity (1W / 1m)	SPLmax	Freq. Range (-6dB)	Weight	Dimensions W x H x D (mm)
6CXN	Coax	6"N / 1"N	8 Ω	150 / 600 W	94 dB	119 dB	80 Hz - 20 kHz	4,5 kg	180 x 290 x 174
8CXN	Coax	8"N / 1"N	8 Ω	280 / 800 W	97 dB	125 dB	70 Hz - 22 kHz	8 kg	240 x 360 x 220
10CXN	Coax	10"N / 1.4"N	8 Ω	400 / 1600 W	96 dB	130 dB	70 Hz - 20 kHz	13 kg	290 x 450 x 300
181	Horn	8" / 1"N	8 Ω	280 / 800 W	95 dB	125 dB	70 Hz - 22 kHz	12 kg	245 x 430 x 280



hd 12CXN

Stage Monitor

The **hd 12CXN** is a high-performance monitor with a coaxial 12"/1.4" driver arrangement and well thought-out features. With over 30 years of practical experience and development of coaxial chassis, a new standard for professional applications has been created with the hd 12CXN.

The newly developed 12"/1.4" coaxial loudspeaker with double neodymium magnet system with 3" voice coils each for bass and treble achieves excellent impulse behaviour thanks to the decoupling of both magnet systems. Due to the deep separation at 900 Hz, the hd 12CXN sounds clear and transparent. The compression driver with polymer diaphragm sits in the woofer magnet system and is directly connected to the cone diaphragm via a BEM-optimized waveguide. This means that there is no shadowing or reflection on the bass membrane from an external horn. The hd 12CXN achieves a conical radiation of 80° without a separate horn.



Variably adjustable monitor angles, a recessed tripod sleeve in the handle, flight and mounting points, as well as a switchable connection panel make the hd 12CXN a real all-rounder. In no time at all, the monitor angle of 32° with the integrated, fold-out risers can be adjusted in two stages to 38° or 45° to suit the situation on the stage. The back of the case is leveled at 15°, so that the artist is also the focus in drum fill applications.

A flying bracket enables cluster formation and use for fixed installations with low ceiling heights. The large bass reflex port ensures a remarkable reproduction of the bass. An important goal of the development process was that the acoustic amplifier of our new 12" coaxial driver is comparable to the usual 15" stage rider models, but with drastically reduced dimensions and only 18 kg weight. With a total height of less than 30 cm, the low-profile housing can be integrated very inconspicuously into any stage setting.

The integrated passive crossover can be deactivated on the connection panel recessed on the back and the hd 12CXN can be operated with BI-AMP if required. The elaborately designed crossover ensures an accurate and phase-coherent summation of the individual paths including frequency range corrections and ensures efficient operation with conventional amplifiers – plug & play – with no additional corrections required. A recessed switch on the connection panel enables the signal input to be switched from pin 1± to 2±. This means that with four-way amplifier outputs in the daisy chain, two AUX feeds can be played out with standard 4-pin cables without special interchangeable cables and the tap can be conveniently switched on the monitor. Four four-pin Speakon NL4 connectors are located on the side and on the back of the monitor to enable flexible connectivity.



The hd 12CXN unfolds its full potential in conjunction with an hd system amplifier. An absolutely flat frequency range with linear phase behaviour enables an even more natural reproduction behaviour and enormous protection against feedback at all levels. In the BI-AMP operating mode and two amplifier channels, the last bit of amplification and transparency can be teased out. Application-specific presets ensure consistency and reliability regardless of where and in which configuration the loudspeaker system is used or combined with hd subwoofer solutions.

Key Features

- operation on any amplifier possible, hd system amplifier recommended
- integrated frequency and phase optimization
- optionally BI-AMP via toggle switch
- wide coverage 80° x 80°
- installation angle 15° / 32° / 38° / 45°
- elegant design
- deep coupling at 900 Hz
- full-range suitable
- compact dimensions
- RAL-Colours optional

Applications

Touring, industry events, theaters, city halls, discos, bars, A/V installations, TV-studios, amusement parks, sports arenas, compact PA

Options

RAL-Colour, weatherproof, various flying and mounting brackets, protective transport cover

suggested Subwoofer

hd Sub15, hd P15, hd Sub18, hd P18, hd Infra212, hd Infra218

Model	Type	Transducers	Impedance	Power Rating RMS / Peak	Sensitivity (1W / 1m)	SPLmax	Freq. Range (-6dB)	Weight	Dimensions W x H x D (mm)
12CXN	Coax	12"N/1.4"N	LF: 8 Ω, HF: 8 Ω passiveXO: 8 Ω	500 / 2.400 W	100 dB	134 dB	55 Hz - 22 kHz	18 kg	450 x 298 x 437

hd MP-Series

Multi Purpose Loudspeaker

The **hd MP10N**, **hd MP12N** and **hd MP15N** are full range cabinets that have been specifically designed and optimized to be true a real multi purpose loudspeaker for permanent installation and mobile applications. The innovative acoustic design achieves a true linear response – not only in terms of flat frequency response, but also in the dynamic range and every other acoustic parameter. Precisely engineered and elaborate crossover ensures outstanding high performance of the compact speakers. The hd MP-Series cabinets are equipped with the most powerful neodymium low-frequency drivers with 600 W / 2400 W (RMS/Peak). The new neodymium high frequency driver is coupled to a large, rotatable horn with a particularly low crossover frequency, which guarantees a high directivity and controlled radiation behaviour in the important voice range. Two different horn variants allow different horizontal and vertical dispersion patterns of 90° x 60° or 60° x 40°.

The acoustic and mechanical design guarantees a coherent, interference-free and balanced reproduction of different music styles and sounds even without additional DSP. Harmonic Design® MPs can easily be connected to any standard power amplifier. Noteworthy is the unique reproduction of transients and the tonal depth and clarity of effects. The SuperVented cabinet design combined with an extremely resilient voice coil paired with the neodymium magnet geometry assembly of the latest technology makes the hd MP-Series a dynamic full range loudspeaker. They are seamlessly integrated into the Harmonic Design® system philosophy by simply adding multiple subwoofers of the hd Sub-Series or hd P-Series as well as driving up to four hd MPs on a single Harmonic Design® system amplifier channel.



hd MP10N
Multi Purpose Loudspeaker



hd MP12N
Multi Purpose Loudspeaker



hd MP15N
Multi Purpose Loudspeaker



The rounded and asymmetrical enclosure is made of high-quality birch multiplex and is provided with a weatherproof polyurethane coating. The integrated 35 mm tripod adaptor allows use on a stand as a front system and is complemented by two practical monitor angles of 32° / 35° and 45° for inconspicuous and resounding monitor applications. Three Speakon connectors – two on the back, one on the bottom – ensure unobtrusive and kinking-free wiring. A powder-coated steel grille with acoustic foam on the inside protects the drivers. An ergonomic handle for transport is placed on top of the cabinets. The hd MP15N has an extra pair of grips on the bottom. Extensive accessories and twelve integrated M8 mounting points offer maximum flexibility for daily changing sound reinforcement tasks. In addition to the extremely robust polyurethane coating in black or white, RAL-Colours are also available.



Key Features

- extreme power rating 600 W RMS / 2400 W Peak
- coverage 90° x 60°, 60° x 40°, rotatable
- high sound pressure and compact dimensions
- frequency and phase optimized crossover
- high dynamics
- linear vote
- pole flange
- monitor angle of 32° / 35° and 45°

Applications

Rental companies, live music, DJ, public buildings, discos, sports arenas, concert halls, theaters

Options

RAL-Colour, various mounting solutions, protective transport cover, weatherproof

suggested Subwoofer

hd Sub15, hd P15, hd Sub18, hd P18, hd Infra218

Model	Transducers	Impedance	Power Rating RMS / Peak	Sensitivity (1W / 1m)	SPLmax	Freq. Range (-6dB)	Weight	Dimensions W x H x D (mm)	Monitor- Angle
MP10N	10"N / 1.4"N	8 Ω	600 / 2400 W	100 dB	133 dB	60 Hz - 20 kHz	15 kg	300 x 520 x 300	35° / 45°
MP12N	12"N / 1.4"N	8 Ω	600 / 2400 W	100 dB	134 dB	55 Hz - 20 kHz	18 kg	354 x 575 x 320	32° / 45°
MP15N	15"N / 1.4"N	8 Ω	600 / 2400 W	101 dB	134 dB	50 Hz - 20 kHz	23 kg	430 x 650 x 380	32° / 45°



hd HLS-Series

HybridLineSource

Revolutionary HybridLineSource-Technology.

The HybridLineSource is a new and worldwide unique loudspeaker system developed by Harmonic Design® which reduces the needed truck space dramatically and improves the quality of a public address system to a new level of uniformity and complete absence of distortions. The HybridLineSource System is equipped with two specially designed high performance 8", 10" or 12" neodymium low frequency chassis and reaches already a sensitivity of 104dB (hd HLS16), 107dB (hd HLS20P) and 108dB (hd HLS24P) in the low-mid-frequency range.



hd HLS16
HybridLineSource



hd HLS20
HybridLineSource



hd HLS24
HybridLineSource



hd HLS24-LT
HybridLineSource

Powerful LineSource-Unit makes the difference.

The exceedingly large-dimensioned high frequency LineSource-section consists of multiple 1.4" exit neodymium compression drivers with a special polymer diaphragm, coupled to dedicated LineSource wave formers generating a cylindrical wave front with a vertical opening angle of 40°. Therefore the throw of a HybridLineSource-System is comparable with a LineArray. Due to the coaxial setup the horizontal coverage pattern is free of interference in the crossover area and perfectly consistent over an angle range of 100°. Double-Hangs become redundant.

Efficiency newly defined.

The innovative and unique hybrid horn-loaded-, vented-, coaxial- and LineArray-enclosure design ensures seamless efficiency, most compact dimensions and undistorted high SPL. The special SuperVentedDesign ensures a dynamic and broadband reproduction below 55 Hz without additional subwoofers in standalone full range mode.

A single HybridLineSource speaker can replace up to six traditional line array speakers.



Easy to combine.

The mechanical structure allows the use on a speaker stand or flown vertical arrays. Every loudspeaker has an integrated 3-point FastRig rigging system where the inter element curvature can be set precisely in 5° steps from 5° to 20°.

Sophisticated accessories save time and costs.

The hd HLS-RF3 is a rigging frame and stand adaptor likewise that may be used to carry a single unit on a speaker stand with precise adjustable tilt in 1° steps from 0° - 20° as well as to fly a vertical array of up to three loudspeakers. This gives best flexibility for daily changing applications while reducing the accessories effort.

Reliable and audiophile.

Operation takes place with Harmonic Design® system amplifiers and guarantees outstanding performance and compatibility even in the worst circumstances as well as highest efficiency in terms of power consumption, truck space and output level. Up to two loudspeakers can be connected in parallel to the Harmonic Design® system amplifiers. An optionally available passive phase optimized crossover allows simple and quick operation on a single system amplifier channel. The 2-way active BI AMP mode guarantees strict neutrality for maximum performance applications. An accurate prediction is possible with EASE Focus.

Sound with system.

Perfectly matched hd TourSys systems comprised of top loudspeakers, subwoofers and system amplifiers as complete Allround-PA systems are available. Several TourSys systems may be combined to realize shows with up to 25,000 listeners.



hd HLS16

HybridLineSource



Key Features

- passive 2-way loudspeaker with 2x 8"N / 2x 1.4"N
- power handling 700 W / 2800 W (AES/Peak)
- coverage 100° x 40°
- frequency- and phase-optimized passive crossover
- innovative hybrid design
- integrated 3-Point FastRig-Rigging

Applications

Rental companies, live music, DJ, concert halls, mobile use, discos, sports arenas

Options

hd HLS16-RF5, hd UniFrame16, hd HLS16-TourCase, RAL-Colour, weatherproof

suggested Subwoofer

hd Sub21, hd Sub18, hd P18, hd Infra218, hd Infra212

Model	Transducers	Impedance	Power Rating RMS / Peak	Sensitivity (1W / 1m)	SPLmax	Freq. Range (-6dB)	Weight	Dimensions W x H x D (mm)
HLS16P	2x 8"N 2x 1.4"N	passive XO: 4 Ω	700 / 2800 W	104 dB	137 dB	70 Hz - 20 kHz	24 kg	370 x 405 x 540

hd HLS20

HybridLineSource



Key Features

- passive 2-way loudspeaker with 2x 10"N / 3x 1.4"N
- power handling 1200 W / 4800 W (AES/Peak)
- coverage 100° x 40°
- optional frequency- and phase-optimized passive crossover (hd HLS20P)
- innovative hybrid design
- integrated 3-Point FastRig-Rigging

Applications

Rental companies, live music, DJ, public buildings, discos, sports arenas, concert halls, mobile use, industry events

Options

Passive XO (HLS20P), hd HLS20-RF3, hd UniFrame16, hd HLS20-TourCase, RAL-Colour, weatherproof

suggested Subwoofer

hd Sub18, hd Sub21, hd Infra212, hd Infra218, hd Infra221

Model	Transducers	Impedance	Power Rating RMS / Peak	Sensitivity (1W / 1m)	SPLmax	Freq. Range (-6dB)	Weight	Dimensions W x H x D (mm)
HLS20	2x 10"N	LF: 4 Ω, HF: 6 Ω	1200 / 4800 W	LF: 107 dB HF: 109 dB	143 dB	70 Hz - 20 kHz	34 kg	400 x 520 x 540
HLS20P	3x 1.4"N	passive XO: 4 Ω		107 dB			36 kg	

hd HLS24

HybridLineSource



Key Features

- passive 2-way loudspeaker with 2x 12"N / 4x 1.4"N
- power handling 1200 W / 4800 W (AES/Peak)
- coverage 100° x 40°
- optional frequency- and phase-optimized passive crossover (hd HLS24P)
- innovative hybrid design
- integrated 3-Point FastRig-Rigging

Applications

Rental companies, live music, DJ, public buildings, discos, sports arenas, concert halls, mobile use, industry events

Options

Passive XO (HLS24P), hd HLS24-RF3, hd UniFrame16, hd HLS24-TourCase, RAL-Colour, weatherproof

suggested Subwoofer

hd Sub21, hd Infra212, hd Infra218, hd Infra221

Model	Transducers	Impedance	Power Rating RMS / Peak	Sensitivity (1W / 1m)	SPLmax	Freq. Range (-6dB)	Weight	Dimensions W x H x D (mm)
HLS24	2x 12"N	LF: 4 Ω, HF: 8 Ω	1200 / 4800 W	LF: 108 dB HF: 110 dB	144 dB	60 Hz - 20 kHz	45 kg	480 x 675 x 560
HLS24P	4x 1.4"N	passive XO: 4 Ω		108 dB			47 kg	

hd HLS24-LT

Long Throw HybridLineSource



The **hd HLS24-LT** is a high-performance line array loudspeaker with fixed dispersion characteristics for medium to large sound reinforcement applications. Based on the globally unique HybridLineSource technology developed by Harmonic Design®, the loudspeaker can be used either as a pure array with up to six hd HLS24-LT modules or as a mixed array with hd HLS24 modules. Thanks to the narrow vertical beam angle of just 15°, applications with large distances and up to 25,000 people can be covered. The angle specified by the housing dimensions greatly simplifies the construction and configuration of an array.

The acoustic and mechanical compatibility with the hd HLS24 and its 40° vertical opening angle make the hd HLS24-LT a useful addition to existing HLS TourSys systems. It expands their possible uses to larger listening areas and thus creates real added value.

With the HybridLineSource system components, configurations that optimally suit the application can be put together at any time:

- 40° vertical coverage with 1x HD HLS24: unbeatably quick to set up and powerful for up to 1,000 people
- 55° vertical coverage with 1x hd HLS24-LT + 1x hd HLS24: for up to 2,500 people
- 70° vertical coverage with 2x hd HLS24-LT + 1x hd HLS24: for up to 5,000 people
- 85° vertical coverage with 3x hd HLS24-LT + 1x hd HLS24: for up to 10,000 people
- 100° vertical coverage with 4x hd HLS24-LT + 1x hd HLS24: for up to 15,000 people
- 90° vertical coverage with 6x hd HLS24-LT: for up to 25,000 people

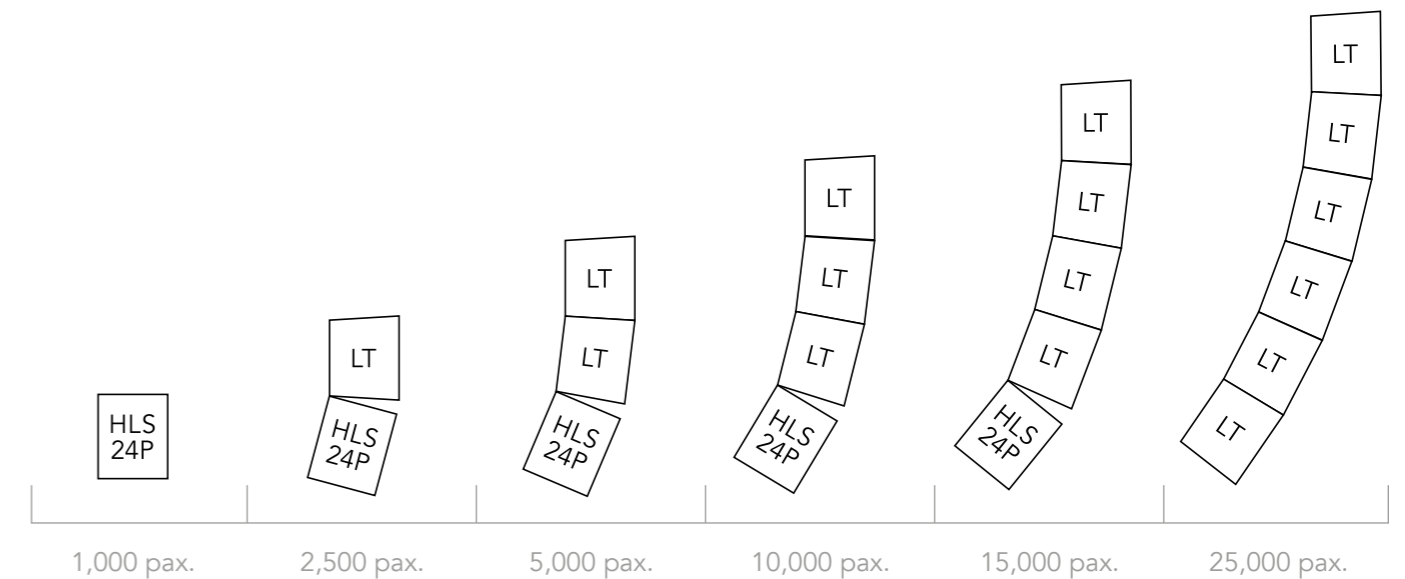

Key Features

- HybridLineSource™ 2x 12"N + 4x 1.4"N
- power handling 1.200 W / 4.800 W (AES/Peak)
- extreme SPLmax 144 dB
- vertical focussed radiation 100° x 15°
- fixed angulation, array with up to 6 elements
- compatible to HLS24 in same array

Applications

Rental companies, live music, DJ, concert halls, mobile use, discos, sports arenas

Options

Passive XO (HLS24P-LT), hd HLS24-RF3, hd UniFrame16, hd HLS24-LT-TourCase, RAL-Colour, weatherproof

suggested Subwoofer

hd Sub21, hd Infra212, hd Infra218, hd Infra221

Model	Transducers	Impedance	Power Rating RMS / Peak	Sensitivity (1W / 1m)	SPLmax	Freq. Range (-6dB)	Weight	Dimensions W x H x D (mm)
HLS24P-LT	2x 12"N 4x 1.4"N	passive XO: 4 Ω	1200 / 4800 W	108 dB	144 dB	60 Hz - 20 kHz	47 kg	480 x 687 x 560



hd LSA12
LineSourceArray Module

complemented by an extreme spatial resolution and depth of effects is exceptional and up to this point only familiar from significantly larger systems.

With the integrated three-point FastRig-rigging system, vertical arrays of up to 16 elements can be flown safely and the vertical coverage angle can be set precisely in 1° steps from 0° to 11°. All components and quick lock pins are fastened to the cabinet. The various horns available for the high frequency units allow symmetrical and asymmetrical horizontal coverage angles for fixed installations, to adjust the audio system precisely to the audience and avoids annoying reflections from walls or obstacles. The special SuperVentedDesign ensures a dynamic and broadband reproduction below 45 Hz in fullrange mode. For high performance applications the system response can be extended with the hd Sub-Series below the subsonic frequency range.

hd LSA-Series LineSourceArray

The **hd LSA12** is an efficient LineArray element of the latest generation, equipped with a specially designed high performance 12" neodymium low frequency chassis. The high frequency unit is equipped with two 1.4" neodymium compression drivers with special polymer diaphragm coupled to dedicated line source wave formers to generate a cylindrical wave front. Brilliant speech intelligibility paired with dynamic tonality and



hd UniFrame16
RiggingFrame

Extensive accessories for easy and safe transport or rigging adaptors like the hd LSA12-SF6 small frame to safely fly up to six elements as well as the larger hd UniFrame16 allows up to flown 16 modules according to BGV-C1. The multi-functional time- and cost saving rigging frame allows practice-oriented flown- or ground-stacked applications with the hd LSA-Series or the hd HLS-Series.



Operation takes place with Harmonic Design® system amplifiers and guarantees outstanding performance and compatibility even in the worst circumstances as well as highest efficiency in terms of power consumption, truck space and output level. The hd LSA12-TourSys1 and the larger hd LSA12-TourSys2 are the perfectly matched complete LineArray systems for beginners and advanced LineArray users. Several TourSys systems can be put together to cover audiences of up to 15.000 listeners.

Up to six loudspeakers can be connected in parallel to the Harmonic Design® system amplifiers. An optionally available passive phase optimized crossover allows a simple and quick operation on a single system amplifier channel. The 2-way active standard mode guarantees strict neutrality and no compromise high-end sound for all maximum performance applications.

An accurate prediction of the radiated sound field as well as calculation the optimum splay angles for the given setup is possible with EASE Focus.

Key Features

- passive 2-way loudspeaker 1x 12"N / 2x 1.4"N
- power handling 600 W / 2400 W (AES/Peak)
- coverage 90° x 15° or 120° x 15°
- optional frequency- and phase-optimized crossover (hd LSA12P)
- most compact dimensions, linear system tuning
- integrated 3-Point FastRig-Rigging
- weight 27 kg

Applications

Rental companies, live music, DJ, concert halls, mobile use, discots, sports arenas

Options

Passive XO (hd LSA12P), hd LSA12-SF6, hd UniFrame16, hd LSA12 TourCase, hd LSA12 Dolly, RALColours, i-version

suggested Subwoofer

hd Sub18, hd P18, hd Infra212, hd Infra218

Model	Transducers	Impedance	Power Rating RMS / Peak	Sensitivity (1W / 1m)	SPLmax	Freq. Range (-6dB)	Weight	Dimensions W x H x D (mm)
LSA12	1x 12"N	LF: 8 Ω HF: 8 Ω	600 / 2400 W	LF: 98 dB HF: 110 dB	138 dB	45 Hz - 20 kHz	27 kg	575 x 340 x 430
LSA12P	2x 1.4"N	passive XO: 8 Ω		105 dB	138 dB		28 kg	
LSA24	2x 12"N	LF: 4 Ω HF: 8 Ω	1200 / 4800 W	LF: 101 dB HF: 110 dB	140 dB	42 Hz - 20 kHz	38 kg	992 x 340 x 430
LSA24P	2x 1.4"N	passive XO: 8 Ω		105 dB	140 dB		40 kg	

hd SpaceAMP-Series

4-Channel Matrix DSP Amplifier

With SPACE, we are introducing a new ecosystem of efficiency and installer friendly workflow. As the name implies, it is designed for use in all types of spaces, including hospitality, retail, venues, cruise ships, fitness and recreation centers, education, corporate, house of worship, and residential.

It offers exceptional sound clarity, reliability, and overall build quality of a premium installation amplifier in a 1/2 19" 1U form factor. It features a state-of-the-art 96 kHz 32-bit FIR DSP and multiple power sizes with 4 channels of output for LowZ and HighZ applications.

All models offer multiple analog inputs and standard audio networking.



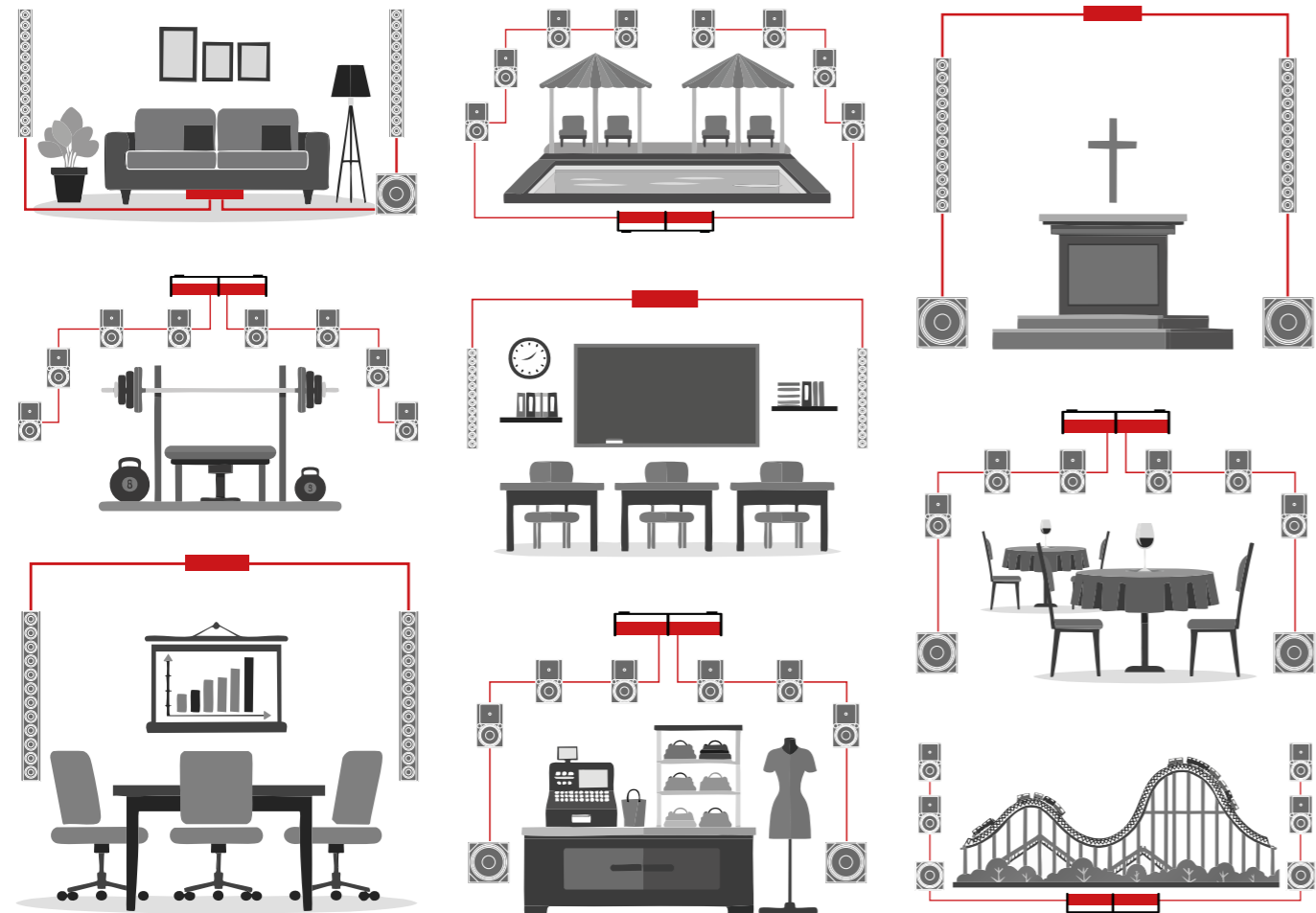







Audio networking capabilities with Dante™/AES67 and an internal Gigabit Ethernet switch with a second port so multiple products can share the same network. All units feature a built-in Wireless Access Point (WAP) for easy connectivity and setup.







Everything you need for the most challenging applications - the built in matrix DSP

Full control at your fingertips:



-  Zone/Grouping
-  Input redundancy
-  Dante™
-  Input matrix/mixing
-  +48V Phantom powered inputs (switchable)
-  Input Limiters
-  16-Band Input EQ
-  Speaker Presets
-  FIR Filter per Output
-  Delay
-  Output Limiters

-  96kHz 32bit High resolution audio
-  GPIO (Volume/Standby/Mute)
-  Wireless
-  1 Gbps Ethernet Switch

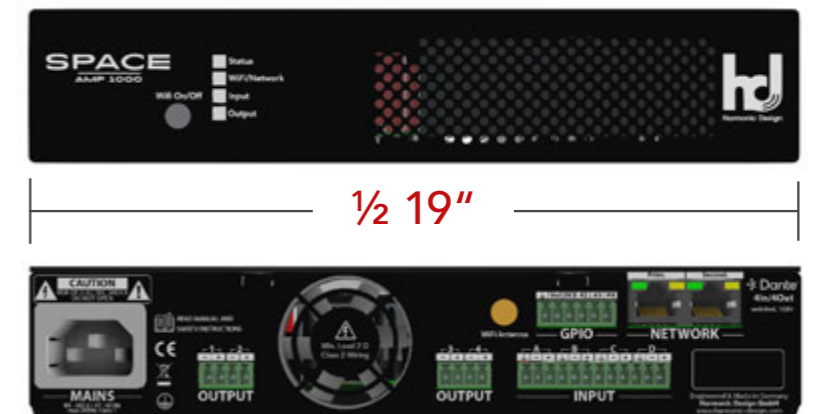

Available rackmount accessories provide multiple options: 1 or 2 SpaceAMP in a 19" rack, mounted on any flat surface, under a table, or in the ceiling.

Model	Input	DSP Filter	Amplifier	Power Rating RMS @ 4 Ω	HighZ 70/100V	Weight	Dimensions W x H x D (mm)
hd SpaceAMP500	4x Analog 4x Dante™	4x4 universal matrix dsp	Class-D with SMPS and PFC	4x 125W	No	1,0 kg	221 x 44 x 172
hd SpaceAMP1000				4x 250W	No	1,0 kg	221 x 44 x 172
hd SpaceAMP1500				4x 375W	Yes	2,5 kg	221 x 44 x 275

hd Qi-Series

DSP Installation Amplifier

The **hd Qi-Series** is a modular equipped, flexible hardware and software solution for driving Harmonic Design® loudspeaker systems. The two height-unit, rack-mount includes four symmetrical inputs, up to four power outputs, and a fully digital signal processor with advanced IIR- and FIR-filtering techniques. The accompanying control software **hd LevelZ** provides comprehensive control of all parameters from a Windows-based computer or directly at the device via the large 3.2" LCD-Display with navigation buttons.



A two- or four-channel Class-D amplifier delivers 500 W for each output channel and supplies ample continuous and peak power to the drivers. They have been invented to fulfill the highest demands on audio quality and reliability for fixed installation projects and mobile applications. Thanks to the high efficiency power stages, the heat dissipation of the amplifier is dramatically reduced in comparison to analogue amplifiers. An intelligent temperature management system guarantees lowest fan noise emission and activates the fans only if the operation mode requires it. The up to two separate switching mode power supplies with PFC have a large operating range from 95V-265V AC 50Hz/60Hz.

In applications that require more amplifier power the two spare XLR-DSP outputs of the 2-channel-version **hd Qi5002** can be used in combination with a conventional amplifier with more power. A system consisting of two top loudspeakers and two subwoofers would be configured that the top loudspeakers are powered through the **hd Qi5002** and the subwoofers through the external power amplifier, but with **hd MultiDSP** processing to ensure best sound.



The integrated digital system controller **hd MultiDSP** offers an extensive equalization architecture that includes equalization, comprised of 16 IIR-Filter in double precision with adjustable slopes, widths and gain, and a FIR filter, both available on each of the inputs and outputs and a multi-stage limiter architecture per output. This enables the opportunity for the system technician to generate a specific FIR-filter for the venue and tune and optimize the system with the approach that is common for conventional multiband-EQs – but without phase distortions.

Key Features

- 4In/4Out High-End **hd MultiDSP**
- up to four power outputs
- modular equipping, separate power supplies
- 500W Class-D amplifier elements with PFC
- FIR- & IIR-Filters
- maximum performance and reliability
- multi-stage Limiter-Architecture (Peak-/RMS-Limiter)
- 3.2" LCD Display with navigation buttons and USB
- control of all features directly at the device without PC
- **hd LevelZ Remote Software**

Applications

- conference rooms
- houses of worship
- public buildings
- concert halls
- live music
- hotels
- A/V installations
- airports

Model	Input/Link	DSP	Amplifier	Power Rating RMS @ 4 Ω	DSP Output	THD+N 1 kHz @ 1 W	Protection Circuits	Weight	Dimensions W x H x D (mm)
Qi5002	4x XLR	4In/4Out FIR-/IIR-Filter	Class-D mit PFC	2x 500 W	2x XLR	0,003 %	Yes	7 kg	19" x 2HE x 300
Qi5004				4x 500 W				-	





hd QT-Series

4-Channel Touring System Amplifier

Harmonic Design system amplifiers are equally suited to all types of touring and installation applications. Across all loudspeaker series, they are at the same time the ideal drive and control center for the greatest possible performance and linearity of Harmonic Design sound reinforcement systems.

The **hd QT-Series** are 4-channel Class-D power amplifiers with switched-mode power supplies specially optimized for long-term maximum performance, which deliver high energy (= power × hold time) for the best LF reproduction. That's why the **hd QT8** generates 4x 2,000 W at 4 ohms and the **hd QT12** 4x 3,000 W at 4 ohms with a crest factor of 3 dB!

Concentrated on the essentials and cost-efficient: Reduced to the most important features in everyday touring and intuitive to use, the hd QT-Series delivers reliable high performance day after day in just 2U. Four analog inputs enable Plug&Play. A generously dimensioned cooling system with temperature-controlled fans allows operation under full load with minimal noise development.

The user interface consists of an LCD display with navigation buttons for visual information and quick access to key functions such as presets, routing matrix, delay and gain. A USB port on the front is used to connect to the proprietary hd LevelZ software suite. This is used for comprehensive system planning, simulation, management and system tuning of all Harmonic Design systems, from the 2.1 active system to large sound reinforcement systems, and offers maximum freedom in sound shaping and loudspeaker management.

The hd MultiDSP combines IIR and FIR filters to create perfectly linearized phase curves and significantly improved impulse responses for a smooth, more natural, transparent and realistic sound experience.

Very practical for rentals that change on a daily basis: the DSP of the system amplifier can be reconfigured using a notebook or power bank without a mains connection and without integration into the network, and it can be quickly and easily prepared for the next use. Time-consuming reconfiguration of basic systems is no longer necessary.

Features

- 4-channel Class-D amplifier with up to 3,000 W
- specially optimized switching power supply with PFC for extreme continuous loads
- 4In/4Out high-end hd MultiDSP
- FIR & IIR filters
- maximum operational reliability and performance
- multi-level limiter architecture (peak/RMS limiter)
- 3.2" LCD with navigation buttons and USB
- Access to all features directly on the device without PC
- hd LevelZ Remote software

Applications

- Disco, concert halls, arena, stadium
- Touring, open air events
- Live sound

Model	Input/Link	DSP	Amplifier	Power RMS @ 4 Ω	THD+N 1 kHz @ 1 W	Protection Circuits	Weight	Dimensions B x H x T (mm)
QT8	4x XLR	4In/4Out	Class-D with PFC	4x 2.000 W	0,003 %	yes	15 kg	19" x 2HE x 503
QT12				4x 3.000 W			16 kg	

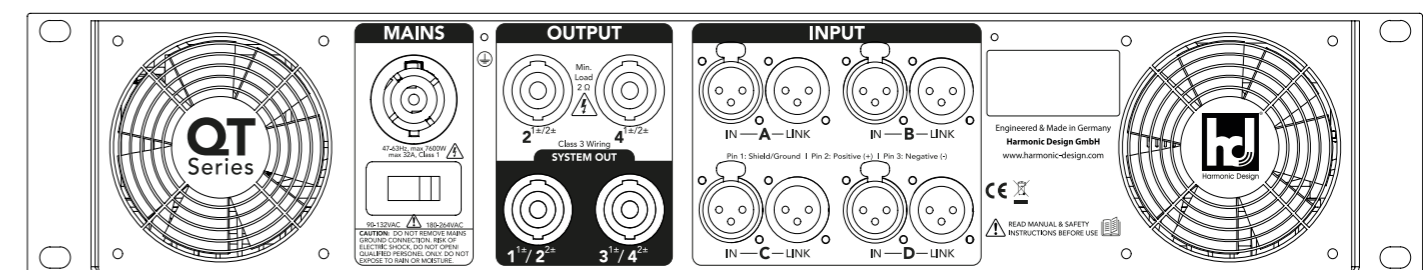

Ultimate System Conception

Choose Your Sound!

Harmonic Design® Systems

The Basic System comprises two top loudspeakers combined with an hd DSP-controlled active subwoofer. PA1 Systems also include a passive slave subwoofer, which can easily be connected to the active sub. PA2 Systems additionally include one active and passive subwoofer each.

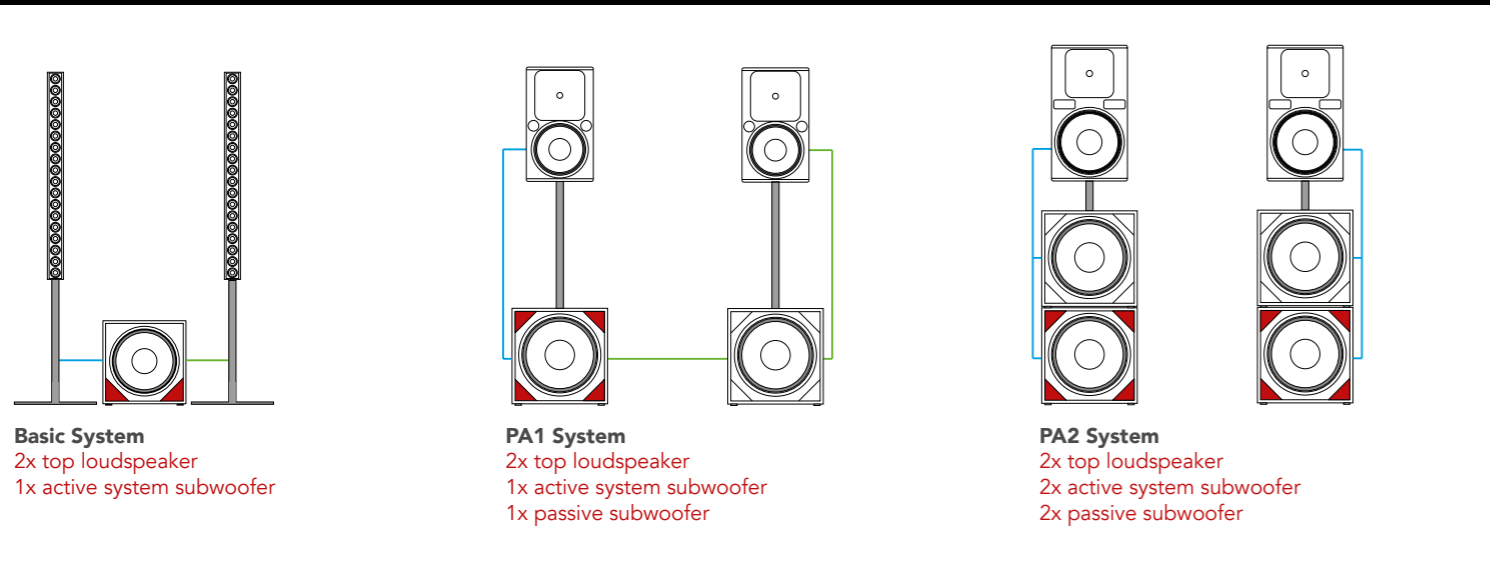

Active System Subwoofers are fitted with the latest high-efficiency Class-D amplifiers. Harmonic Design®'s integrated four-channel hd MultiDSP with FIR/IIR filter technology allows a phase coherent adjustment between subwoofers and tops, guaranteeing a balanced homogeneous sound at any sound level. Harmonic Design®'s own, uncompromising developed factory presets using FIR-filtering and GroupDelay-Correction technology are designed to ensure linear sound reproduction even in the most diverse sound reinforcement situations. Using the integrated audio processing tools (EQ, delay, etc.), individual settings can also be created and saved as presets. All systems are perfect tools for engineers, DJs, musicians and rental companies according to their linear and genuine sound reproduction.

hd LevelZ

Remote Software

The hd MultiDSP platform with open architecture guarantees a perfect control of all relevant system components thanks to the all new and easy to use, windows-based remote software **hd LevelZ**. This new DSP platform enable now all processing and remote features of large scale sound systems in a smart plug & play device. The input section comprises a routing matrix, a function generator (sine and noise) and per input 16 IIR-Filter in double precision with adjustable type, slope, width, gain and a 384-Taps FIR-Filter. Per output channel there are 16 IIR-Filter in double precision with adjustable type, slope, width, gain, 384-Taps FIR-Filter, up to 100 ms delay, phase reversal, peak-limiter, RMS-limiter, gain and mute.

20 Factory-Presets are available for all Harmonic Design® loudspeaker configurations to be accessed directly at the device that one can always reset the settings to default. This guarantees the best reliability for the connected loudspeakers and ensures a dynamic and linear sound reproduction. For specific user settings there are another 20 freely configurable User-Presets to adjust the system to the individual demands and taste. Control via the software enables most detailed changes and manage unlimited User-Preset configurations. All settings will be loaded even from totally unknown devices and may be adjusted after few seconds of synchronization.

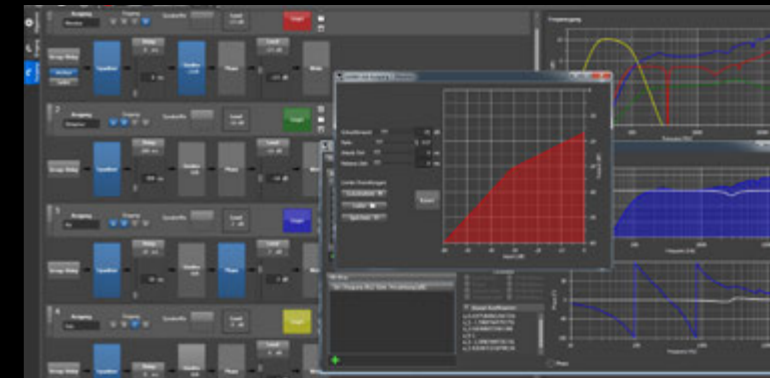

Key Features

- 16 IIR-Filter (double precision) per input/output
- 384 Taps FIR-Filter per input/output
- maximum performance and best reliability
- multistage Limiter-Architecture (Thermal-/Peak-/RMS-Limiter)
- 3.2" LCD Display with navigation buttons and USB
- control of all features directly at the device without PC
- Windows based remote software hd LevelZ

Systemproposals

Basic Systems



hd M8/P12stereo

PointSource Stick System

- 2x hd M8 PointSource Stick
- 1x hd P12stereo active System Subwoofer
- point source characteristics
- conference, multimedia and speech up to 100 people
- ultra compact and lightweight
- wide and uniform dispersion
- inconspicuous optics
- plug & play
- **system power: 800Wrms**



hd ML24/P15

LineArray Stick System

- 2x hd ML24 LineArray Stick
- 1x hd P15 active System Subwoofer
- smooth coverage due to cylindrical wave propagation
- concert halls, live music, DJ and speech up to 150 people
- compact and lightweight
- best optical integration into room architecture
- large range
- rich bass
- **system power: 2.200Wrms**

hd 6CXN/P15

Multi Purpose PA-System

- 2x hd 6CXN Coaxial Loudspeaker
- 1x hd P15 active System Subwoofer
- point source characteristics
- wide and uniform dispersion
- multimedia, live music, DJ and speech up to 150 people
- inconspicuous optics
- rich bass
- compact and lightweight
- DSP-AUX for Monitor / Delayline
- plug & play
- **system power: 1.300Wrms**



hd 8CXN/P15

Multi Purpose PA-System

- 2x hd 8CXN Coaxial Loudspeaker
- 1x hd P15 active System Subwoofer
- point source characteristics
- wide and uniform dispersion
- multimedia, live music, DJ and speech up to 200 people
- inconspicuous optics
- rich bass
- compact and lightweight
- DSP-AUX for Monitor / Delayline
- plug & play
- **system power: 1.560Wrms**



Systemproposals

Basic Systems

Systemproposals

PowerLine Stick PA1-Systems



hd PL12/P15-PA1

PowerLine Stick System

- 2x hd PL12 PowerLine Stick
- 1x hd P15 active System Subwoofer
- 1x hd Sub15 Subwoofer
- uniform coverage thanks to cylindrical wave propagation
- live music, DJ and speech up to 200 people
- large throw and high SPL
- inconspicuous optics
- rich bass
- compact and lightweight
- best optical integration into room architecture
- DSP-AUX for Monitor / Delayline
- plug & play
- **system power: 2.900Wrms**



hd PL16/P18-PA1

PowerLine Stick System

- 2x hd PL16 PowerLine Stick
- 1x hd P18 active System Subwoofer
- 1x hd Sub18 Subwoofer
- uniform coverage thanks to cylindrical wave propagation
- live music, DJ and speech up to 300 people
- large throw and high SPL
- inconspicuous optics
- best optical integration into room architecture
- DSP-AUX for Monitor / Delayline
- impressive low-end reproduction
- plug & play
- **system power: 3.700Wrms**

hd 8CXN/P15-PA1

Multi Purpose PA-System

- 2x hd 8CXN Coaxial Loudspeaker
- 1x hd P15 active System Subwoofer
- 1x hd Sub15 Subwoofer
- point source characteristics
- wide and uniform dispersion
- multimedia, live music, DJ and speech up to 200 people
- inconspicuous optics
- rich bass
- compact and lightweight
- DSP-AUX for Monitor / Delayline
- plug & play
- **system power: 2.560Wrms**



hd 10CXN/P15-PA1

Multi Purpose PA-System

- 2x hd 10CXN Coaxial Loudspeaker
- 1x hd P15 active System Subwoofer
- 1x hd Sub15 Subwoofer
- point source characteristics
- wide and uniform dispersion
- multimedia, live music, DJ and speech up to 300 people
- inconspicuous optics
- rich bass
- compact and lightweight
- DSP-AUX for Monitor / Delayline
- plug & play
- **system power: 2.800Wrms**



Systemproposals

PA1 Systems

Systemproposals

PA1 Systems



hd MP10N/P18-PA1

Multi Purpose PA-System

- 2x hd MP10N Multi Purpose Loudspeaker
- 1x hd P18 active System Subwoofer
- 1x hd Sub18 Subwoofer
- live music, DJ and speech up to 500 people
- compact and lightweight
- high SPL
- DSP-AUX for Monitor / Delay
- various dispersions possible: 90° x 60°, 60° x 40°
- plug & play
- **system power: 3.500 Wrms**



hd MP12N/P18-PA1

Multi Purpose PA-System

- 2x hd MP12N Multi Purpose Loudspeaker
- 1x hd P18 active System Subwoofer
- 1x hd Sub18 Subwoofer
- live music, DJ and speech up to 500 people
- compact and lightweight
- high SPL
- DSP-AUX for Monitor / Delay
- various dispersions possible: 90° x 60°, 60° x 40°
- plug & play
- **system power: 3.500Wrms**

Systemproposals

PA2 Systems

hd PL16C/P18-PA2

PowerLine Stick System

- 2x hd PL16 PowerLine Stick
- 2x hd PLC Cardioid Module
- 2x hd P18 active System Subwoofer
- uniform coverage thanks to cylindrical wave propagation
- live music, DJ and speech up to 300 people
- large throw and high SPL
- superb low-mid directivity control due to cardioid module
- inconspicuous optics
- best optical integration into room architecture
- impressive low-end reproduction
- plug & play
- **system power: 4.880Wrms**



hd HLS20/P18-PA2

Power-PA-System

- 2x hd HLS20 HybridLineSource
- 2x hd P18 active System Subwoofer
- 2x hd Sub18 Subwoofer
- live music, DJ and speech up to 800 people
- extreme high SPL
- 2x DSP-AUX for Monitor / Delay
- 2x amplifier outputs with DSP processing for Monitor / Delay
- large range due to cylindrical wave propagation characteristic
- compact dimensions, light-weight and easy handling
- plug & play
- **system power: 6.600Wrms**



Systemproposals

TourSys1 Systems



hd HLS20-TourSys1

Allround PA-System

- 2x hd HLS20P HybridLineSource
- 2x hd Infra218 Hybrid Subwoofer
- 1x hd QT12 system amplifier
- live music, DJ and speech up to 1.000 people
- compact dimensions, light-weight and easy handling
- extreme high SPL
- remote surveillance & remote control
- plug & play
- **system power: 8.400Wrms**



hd HLS24-TourSys1

Allround PA-System

- 2x hd HLS24P HybridLineSource
- 2x hd Infra218 Hybrid Subwoofer
- 1x hd QT12 system amplifier
- live music, DJ and speech up to 1.200 people
- compact dimensions, light-weight and easy handling
- extreme high SPL
- remote surveillance & remote control
- plug & play
- **system power: 8.400Wrms**

Systemproposals

TourSys2 Systems



hd HLS24-TourSys2

Allround PA-System

- 2x hd HLS24P HybridLineSource
- 4x hd Infra218 Hybrid Subwoofer
- 1x hd QT12 system amplifier
- live music, DJ and speech up to 1.500 people
- compact dimensions, light-weight and easy handling
- extreme high SPL
- remote surveillance & remote control
- plug & play
- **system power: 12.800Wrms**



hd LSA12-TourSys2

LineArray-System

- 12x hd LSA12P LineSource Array Module
- 6x hd Infra218 Hybrid Subwoofer
- 2x hd QT12 system amplifier
- live music, DJ and speech up to 2.500 people
- compact dimensions, light-weight and easy handling
- high SPL
- smooth coverage
- remote surveillance & remote control
- cardioid setups possible
- plug & play
- **system power: 18.200Wrms**





hd AudioBar & hd VideoBar

All-in-One Solution

To be comprehended at last.

An essential part of human interaction is the sharing of thoughts, visions and feelings through communication. In the professional environment, this is happening more and more with the help of virtual media, for example for video conferences and online meetings – without personal contact.

Important aspects such as the dynamics, voice colour, articulation, expression and emotions of the counterpart go far beyond pure speech intelligibility. For the experience of an authentic meeting, the full information content of language must not get lost on the transmission path. Otherwise the participants' ability to concentrate and be productive suffers. Misunderstandings are inevitable. The uncompromising use of the latest pro audio technology meets the highest audiophile requirements and combines complex multimedia components in one device that anyone can operate.

With the **hd AudioBar** and **hd VideoBar** you can create a pleasant collaboration environment for a respectful and appreciative encounter between colleagues and business partners without any technical effort.

Independent ecosystem.

The hd AudioBar and hd VideoBar combine loudspeakers, amplifiers, signal processors, mixer, microphone and wireless audio as well as camera technology in one device. Together with a screen and computer, they form a full-fledged collaboration system and make additional components and their complex cabling superfluous.



Real music enjoyment



Excellent intelligibility



Perfect picture



Top connectivity



Training



Lecture



Video conference



So that you are always at the center of the discussion
The hd VideoBar enables easy integration of the award-winning Huddly IQ camera. Installation is done in next to no time: screw the camera onto the included mounting bracket, insert it into the hd VideoBar from behind, plug in the USB cable – done!

Model	hd AudioBar	hd VideoBar
Customization	✓	✓
Integrated subwoofer	✓	✓
Integrated DSP amplifier	✓	✓
Digital mixer functions	✓	✓
Camera integration possible	✗	✓

Plug & Play

Ready to go for every meeting

Intelligent control center – ready for the future

A multi-channel digital signal processor based on our **hd ProDSP** platform is the heart of the system. It manages all inputs and outputs, uses the latest algorithms for sound optimization and is also equipped with highly efficient power amplifiers. As soon as it is processed and digitized, the audio signal is passed on to the amplifier section in the highest audiophile quality without loss.

BringYourOwnDevice-ready and wireless audio thanks to the integrated wireless interface. For maximum connectivity without cable clutter, the soundbar can play the sound of a TV or any wireless-enabled device with high-resolution audio formats.

As with all Harmonic Design® speaker systems, we use FIR filter technology to achieve a perfect sound experience. And when it gets louder, intelligent protective circuits ensure maximum operational safety – 24/7!

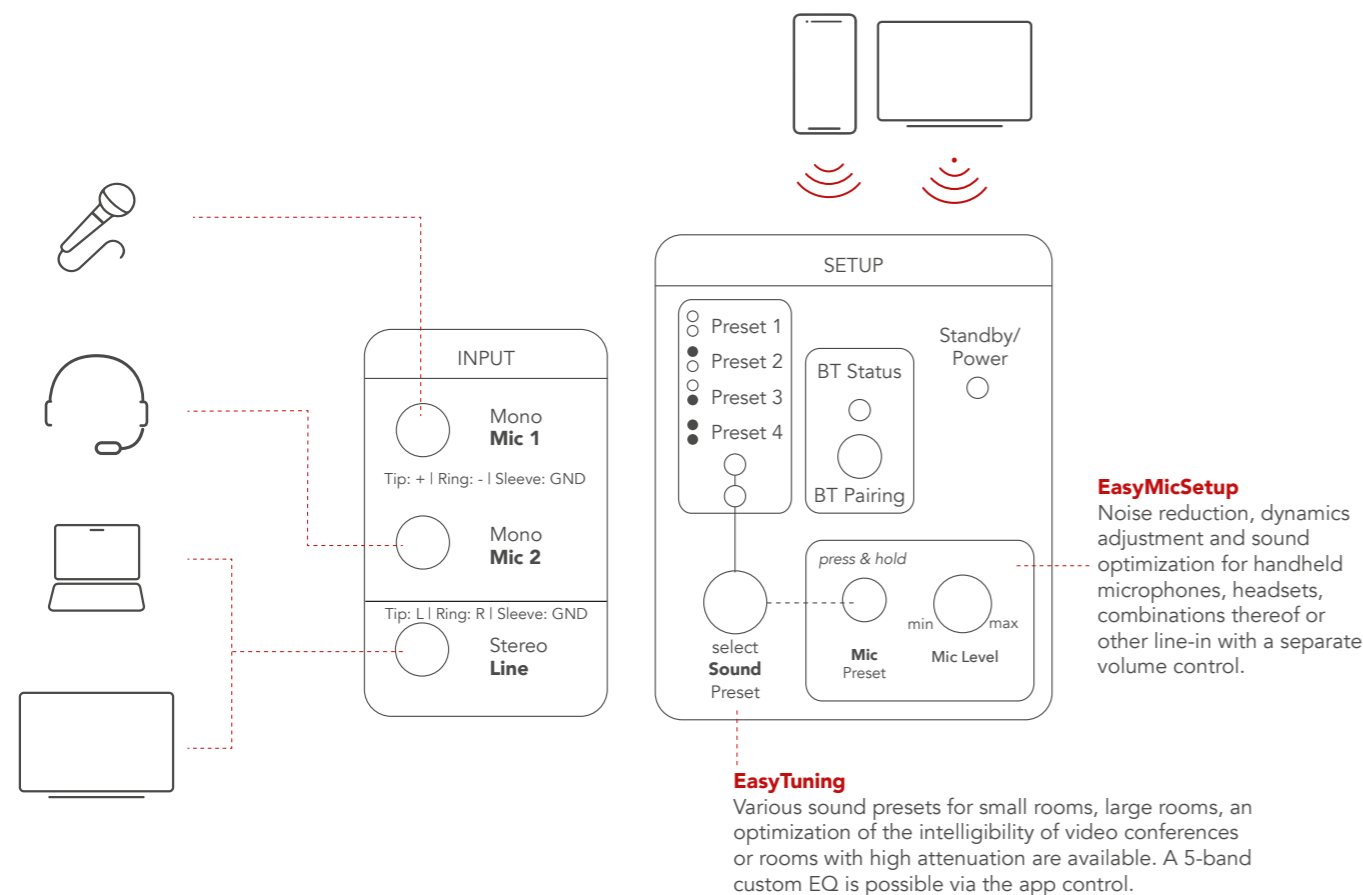

Perfect integration

Premium audio for speeches and lectures

The **hd AudioBar** and **hd VideoBar** are designed for a wide range of requirements and room scenarios.

They offer a great deal of flexibility and simplicity. All models are equipped with two inputs for a wide variety of wireless microphone components and, thanks to the latest signal processing, are optimized for maximum speech intelligibility in speech applications. After all, the audience should be able to concentrate on the essentials: on what you have to say.

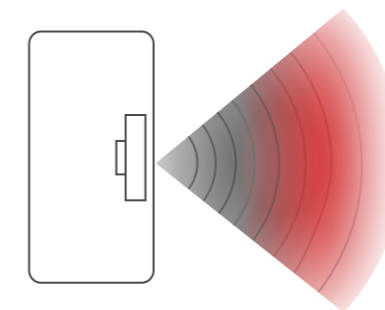
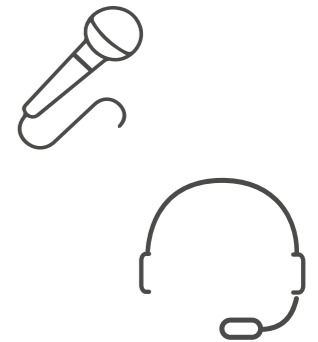

Stereo loudspeaker.

Special dual-concentric speakers ensure that you can enjoy the full sound spectrum in the entire room.

The symmetrical radiation makes the positioning of the hd AudioBar and hd VideoBar easier and reaches more listeners. Whether above or below the presentation area: every single nuance is understood

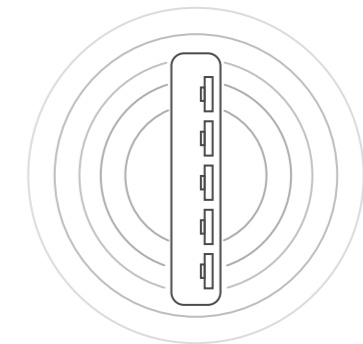

Subwoofer-Array.

A soundbar not only has to convince with speech intelligibility, but also give your videos goose bumps in the lowest octave. In contrast to a single subwoofer, an entire subwoofer array ensures a more controlled, profound bass without booming when playing media sound. Pure concert feeling!



hd AudioScreenSys

For large multimedia presentation areas

The **hd AudioScreenSys** is an audiophile all-in-one stereo sound reinforcement solution with integrated subwoofers and 4+2In DSP amplifier for larger screens, LED walls and projection surfaces in mobile or fixed multimedia applications. The hd AudioScreenSys consists of one active column speaker and one passive column speaker. Each column speaker is equipped with a 3.5"+1" dual-concentric midrange-tweeter unit with two additional 3" D'Appolito woofers and a subwoofer array of five 3.5" long-throw woofers. This arrangement produces directional vertical dispersion in the low-mid range and provides greater coverage.

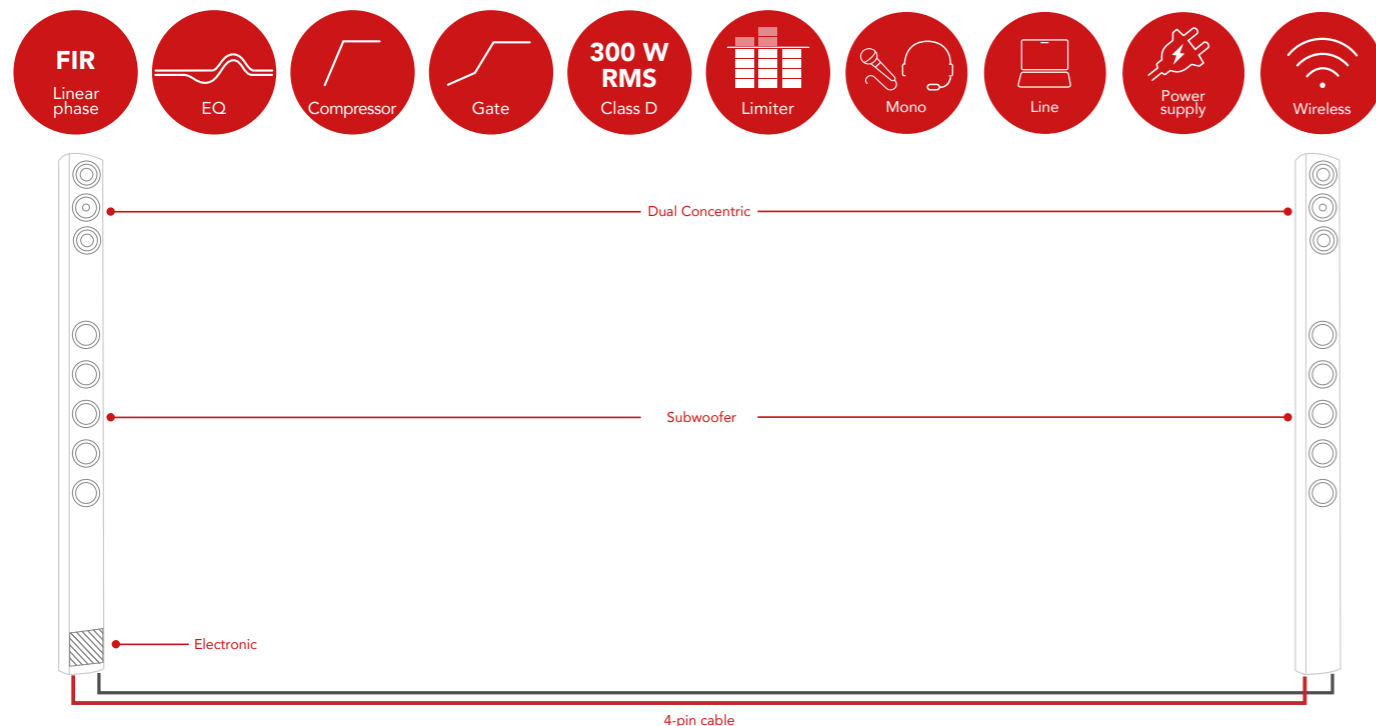

The active column speaker contains all the amplifier electronics for the entire left/right system. Our 4+2In/4Out high-end hd ProDSP platform with highly efficient 4-channel Class D amplifiers with a total of 300 W RMS ensures the highest operational reliability, unique headroom and the best possible audio quality at all times for presentations, video conferences and music playback.

The input stage consists of a stereo line-in for fixed connection of the TV or media sound and two microphone line-ins for connection of radio microphones, headsets, clip-on microphones or any line signals. A volume control for both microphone channels is located on the rear recessed connector panel. Four preset sound presets and microphone presets, suitable for the most common microphone types and models, can be recalled via buttons on the connector panel. A permanently active dynamics processor with expander, compressor and gate function for the microphone channels ensures ideal microphone operation without additional hardware. BYOD ready thanks to the optionally available Wireless Audio Interface.

The hd AudioScreenSys is the optimal sound reinforcement solution in the course of the digitalisation of the working world. For the sound reinforcement of media steles, larger conference rooms, museums, educational institutions or hotels, the state-of-the-art, reliable and easy-to-use all-in-one complete solution can be used cost-efficiently and makes external DSPs and matrix systems superfluous.

The shapely aluminium housing can be manufactured exactly to the height of the screen or presentation surface on request. The option of custom painting in all RAL-CLASSIC colors ensures seamless integration into the architecture. The integrated, continuous 13 mm T-slot on the rear is used to accommodate customised wall brackets. For direct wall mounting, the column speakers can be fixed flush to the wall with the optionally available L-angle wall bracket.

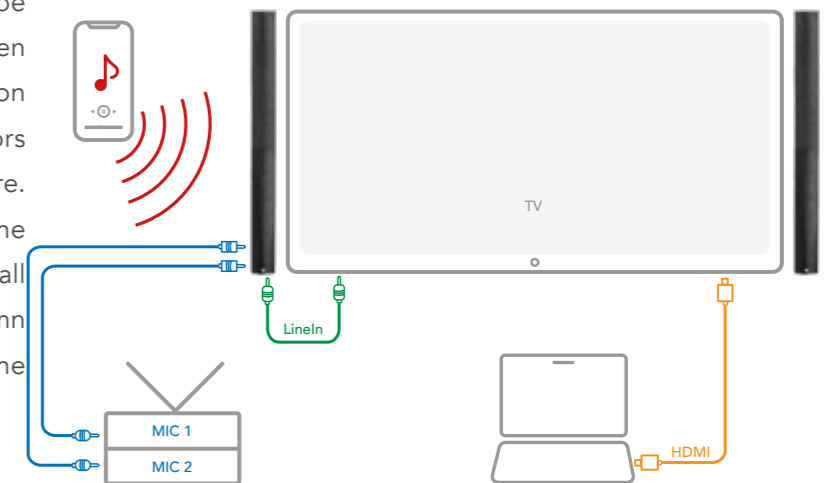

Features

- Plug&Play complete audio solution with digital mixer functions
- 2x microphone inputs + media sound
- 4 microphone presets + sound presets each
- Wireless audio optional

Features of the DSP electronics

- 4-channel Class-D amplifier with 300 W RMS
- 4+2In/4Out high-end hd ProDSP with > 50 MIPS
- LinearPhase FIR filter

Acoustic and mechanical features

- active and passive column speakers in stereo
- 2 1/2-way midrange-tweeter unit for high range and controlled dispersion
- integrated subwoofer array for extended frequency response of 45 Hz
- from 75" screen diagonal and special design in special lengths up to 3 m

Application

Large media columns, educational institutions, museums, conference rooms, training rooms, hotels

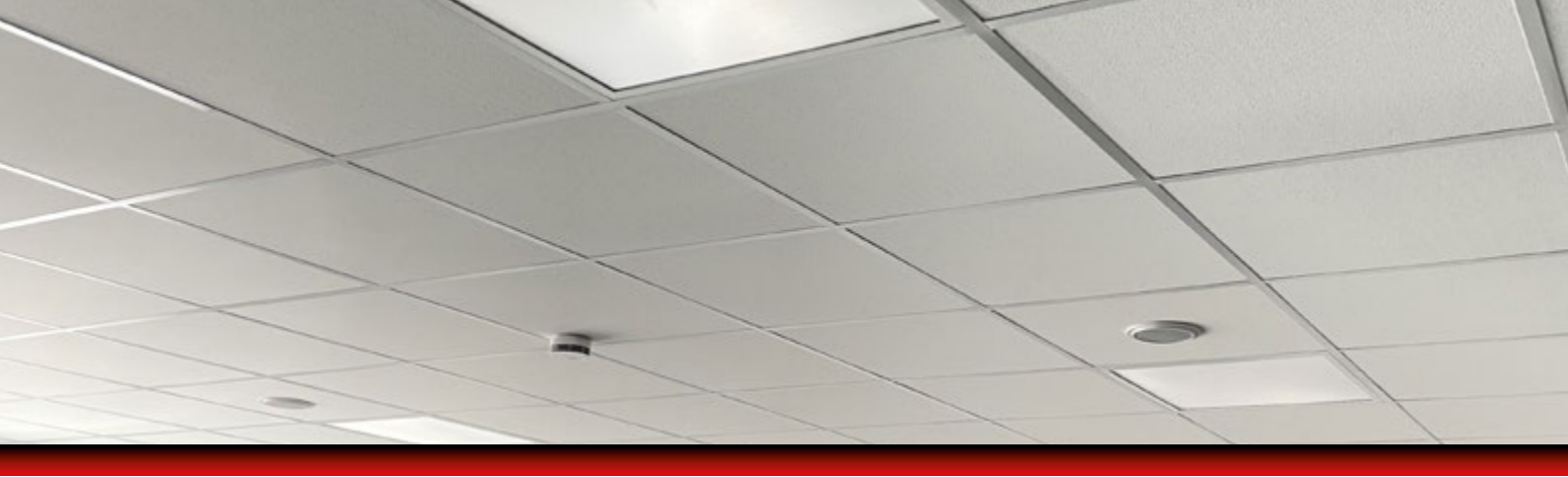

hd IC-Series Ceiling Speakers

Integration made easy.

The Harmonic Design® integrated ceiling loudspeakers are characterized by uncompromising reproduction quality and are in no way inferior to conventional loudspeakers. The basis is the innovative dual-concentric loudspeaker chassis from the hd CCX series, which ensures that the same high-quality sound is achieved in inconspicuous applications as with all Harmonic Design® loudspeaker systems.

In contrast to normal loudspeakers, our dual concentric consists of two drivers that have been physically combined into one. The tweeter unit is on the same axis as the woofer unit. This is the only way that the sound energy is radiated evenly in the horizontal and vertical planes and offers exceptional sound quality within the radiation area. The areas to be covered can thus be covered homogeneously and precisely defined.

The **hd IC230** can be driven by any low-impedance power amplifier or existing 70V / 100V mains - even without DSP - making it the ideal solution for decentralised or small sound reinforcement applications such as hotels, restaurants or conference rooms. The 5-step mode switch allows the user to select between low impedance operation at 8 ohms, mute or high impedance operation at 30 W | 15 W | 7.5 W in 100 V networks. The hd IC230 can be easily installed in the ceiling using quick-release clips. The housing has a shallow depth of just 99mm and can be used in ceilings up to 52mm thick. A mounting template is supplied for efficient on-site installation. A paint cover makes it easy to paint or varnish the front grille and cover.



hd PC-Series Pendant Speakers

Always in the center of the sound world.

Harmonic Design® pendulum ceiling loudspeakers are ideally suited for rooms with high ceilings and sophisticated architecture. The minimalist design with a clear shape as cylinder and similarity to hanging lamps is suitable for inconspicuous and large-scale sound reinforcement tasks such as in shopping centers, showrooms, hotels, restaurants, or airports.

The well-formed and durable aluminium housing with bass reflex tuning allows full-fledged music reproduction despite the most compact dimensions and can be customized in terms of colour, surface and pattern. The **hd PC150** is also based on the innovative dual-concentric loudspeaker chassis from the hd CCX-Series and, thanks to the detachable bracket, can be easily suspended from ceilings with variable heights using a suitable combination cable including wire rope.

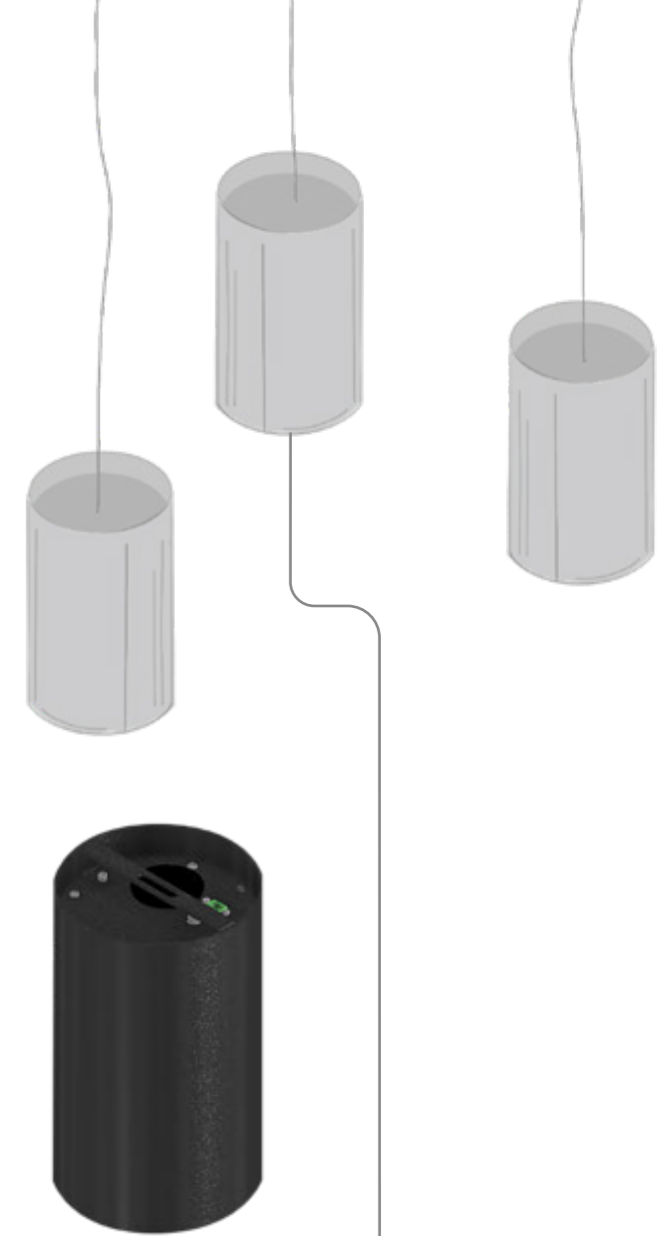

Model	Radiation	Transducers	Impedance LowZ	Transformer HighZ	Power Rating RMS / Peak	Sensitivity (1W / 1m)	SPLmax	Freq. Range (-6dB)	Weight	Dimensions Ø x H (mm)
IC230	80° x 80°	3.5" Woofer + 1" Tweeter	8 Ω	30 W 15 W 7.5 W @ 100 V	40 / 55 W	88 dB	111 dB	70 Hz - 22 kHz	2.0 kg	230 x 106
PC150				15 W 7.5 W 3.8 W @ 70 V	40 / 55 W	88 dB		65 Hz - 22 kHz	2.5 kg	150 x 250

Accessories

Well thought out & useful

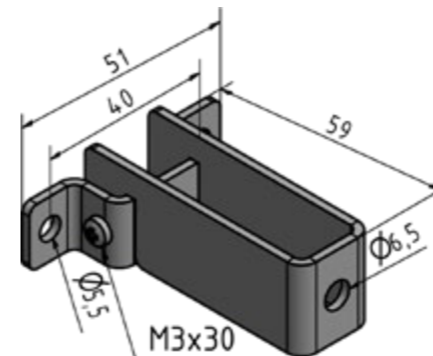
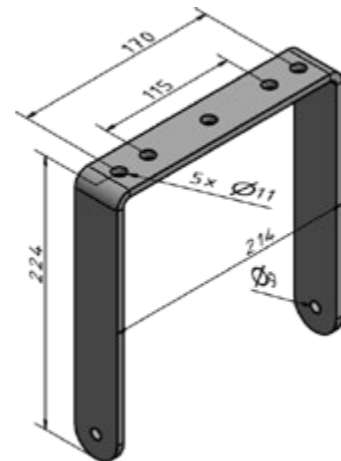
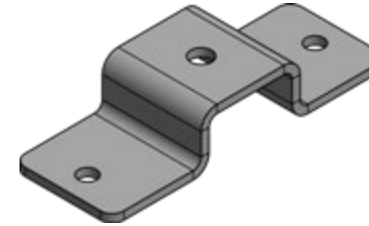
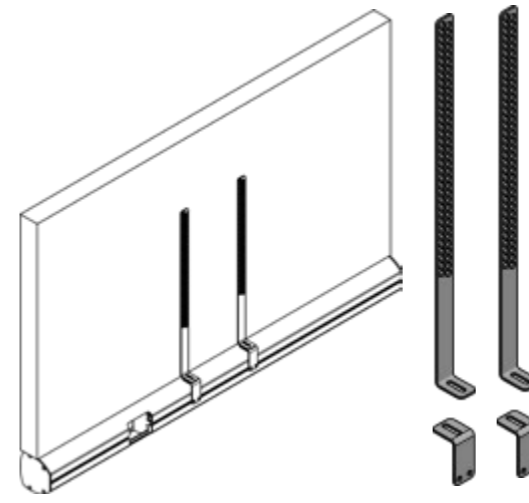

References

Fascinatingly versatile



Architecture and technology are no contrasts.

All speakers and accessories may be coloured like the surroundings to ensure an inconspicuous optics and best integration into room architecture or may be protected with the outdoor option from damage due to varying climate. Simulation data of the loudspeaker help during the planning of installations and generates planning certainty.

No compromises at mobile usages.

The active plug & play systems are built for daily operation even under the worst challenging circumstances. They are a reliable tool for live sound engineers and musicians all over the world that not only go in for quality but also for inconspicuous optics, ease of use, seamless flexibility and efficiency.



At home on the main stages of the world.

Harmonic Design® systems has been a symbol for audio-ophile reproduction of spoken word and sound since 1980. They accomplish what they are designed to do on multiple stages, events and venues: open your artistry to a wide audience.

